



ROBERS®

INDUSTRIAL
2016-2018

**casa
lumi**
www.casalumi.de

Sie erhalten sämtliche
Robers-Produkte
bei Casa Lumi, dem
Fachhändler für exklusive
Manufaktur-Leuchten.
Wir beraten Sie gerne!



ROBERERS®





Seit 1964 werden in unserem Familienunternehmen in Südlohn Leuchten auf höchstem Niveau und in hoher Qualität hergestellt.

Die Marke ROBERS steht für Tradition, Nachhaltigkeit und zeitlose Gestaltung. Entwicklung und Fertigung befinden sich unter einem Dach in unserem Werk in Südlohn. Dadurch erreichen wir eine sehr große Flexibilität. Die Leuchten werden von erfahrenen Schmieden in sorgfältiger Handarbeit hergestellt somit wird jedes Stück zu einem Unikat.

Die verschiedenen Standardoberflächen haben wir auf Seite 82 abgebildet. Es werden nur hochwertige Materialien wie seewasserbeständiges Aluminium, Grauguß, Stahl – feuerverzinkt, Edelstahl und Kupfer verwendet.

Unsere Leuchten werden lichttechnisch ständig weiterentwickelt und können selbstverständlich mit LEDs und anderen innovativen Leuchtmitteln bestückt werden. Dadurch sind sie für die Zukunft gerüstet.

Die Leuchten sind anschlussfertig verdrahtet und nur mit hochwertigsten elektrischen Komponenten bestückt.

Aufgrund unserer Fertigungsmöglichkeiten sind wir in der Lage auf persönliche Kundenwünsche einzugehen. Dabei können wir nach Ihren Vorstellungen arbeiten oder Entwürfe für Sie ausarbeiten. Zeitlose Gestaltung, moderne LED-Technik, Industriestahl und leidenschaftliche Handwerkskunst bilden die Basis für unsere INDUSTRIAL Produktserie.



Since 1964 we have been producing high quality lighting fixtures in our family owned company in Südlohn / Germany.

The brand ROBERS symbolizes tradition, sustainability and timeless design. Development and production are under one roof at our plant in Südlohn. Thus, we achieve a high degree of flexibility.

Our lighting fixtures are carefully crafted by experienced blacksmiths. In this way each item becomes a unique touch.

For different finishes see page 82. Only high-quality materials are used such as seawaterresistant aluminium, cast iron, hot-galvanized steel, stainless steel and copper.

Our lighting fixtures are constantly evolving regarding lighting technology and can of course be equipped with LEDs and other innovative light sources. Thus they are well prepared for the future.

The lighting fixtures are ready for installation at site and are equipped with high class electrical components.

Due to our manufacturing capabilities we can respond to special customer requests. Hereby we can realize your own ideas or we can give you our proposals.

Timeless design, modern LED technology, hard steel and passionate craftsmanship are the base for our INDUSTRIAL product line.

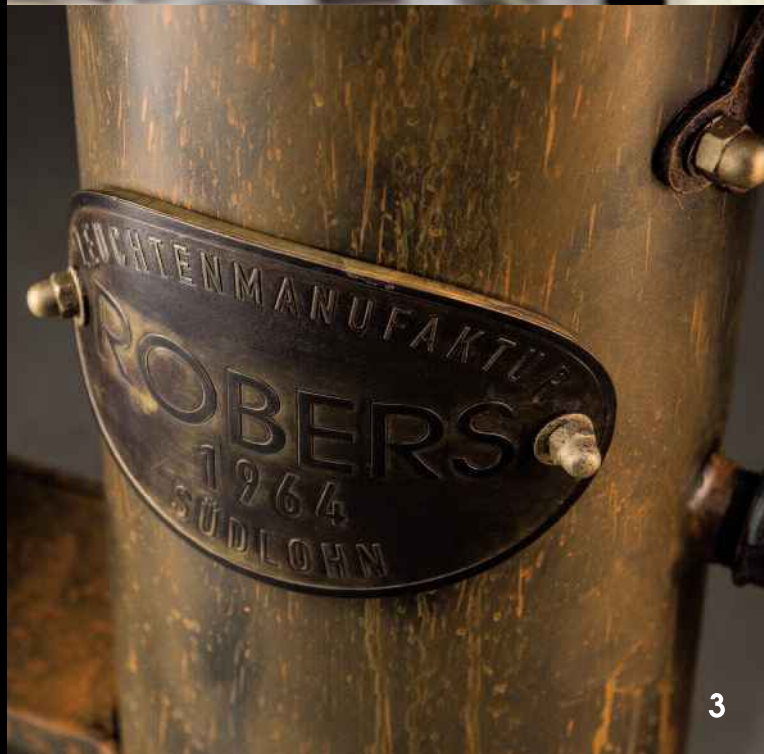



 Начиная с 1964 года на нашем семейном предприятии в городе Зюдлон в Германии мы производим светильники высочайшего качества.

Марка Robers – это традиции, основательность и классический дизайн.

Новые идеи светильников рождаются в нашем доме и здесь же воплощаются в жизнь высококлассными мастерами ручнойковки. Это позволяет очень гибко реагировать на пожелания клиентов. Каждая работа мастеров уникальна.

В производстве используются только высококачественные материалы, такие как устойчивый к воздействию морской воды алюминий, чугун, оцинкованная сталь и медь.

Образцы покрытий, используемых при производстве изделий, представлены на странице 82.



Мы идем в ногу с техническими инновациями и уже сегодня оснащаем светильники светодиодными (LED) и другими современными энергосберегающими источниками света.

Светильники поставляются укомплектованными только высококачественными электрическими компонентами и готовы к установке.

Наши производственные возможности позволяют осуществить самые изысканные пожелания клиента. Мы реализуем ваши представления по разработанному нами эскизу.





Depuis 1964 notre entreprise familiale installée à Südlohn en Allemagne produit des luminaires de prestige d'une qualité remarquable.

La marque Robers est reconnue pour l'authenticité et la valeur ajoutée de leurs créations intemporelles. Le fait de développer et de fabriquer les produits dans l'usine de Südlohn apporte une très grande souplesse d'adaptation. Les lampes sont réalisées dans le respect des traditions artisanales afin que chaque pièce reste unique.

Le panel des différentes finitions est représenté à la page 82.

Un design intemporel, une technologie LED moderne, de l'acier et des artisans passionnés constituent l'essence de notre ligne INDUSTRIAL.

Nous n'utilisons que des matériaux de grande qualité comme de l'aluminium insensible à l'eau de mer, de la fonte, de l'acier galvanisé à chaud, de l'innox, du bronze.

Nos lampes évoluent constamment et sont adaptées à recevoir des Leds et les nouvelles techniques d'éclairage.

Les lampes sont dotées de câblages et de composants électriques de qualité. Elles sont livrées prêt à brancher.

Grâce à notre adaptabilité, nous sommes en mesure de satisfaire les souhaits de nos clients. Nous pouvons travailler selon vos critères ou développer pour vous des projets spécifiques.



HL 2610



HL 2610
HÄNGELEUCHE / SUSPENSION LAMP

| | |
|----------------------|---------------------------|
| FASSUNG / SOCKET: | 3 X E 27 / 3 X E 26 |
| LÄNGE / LENGTH: | 970 MM / 38" |
| BREITE / WIDTH: | 115 MM / 4,5" |
| HÖHE / HEIGHT: | 446 MM / 17,5" |
| OBERFLÄCHE / FINISH: | EISEN NATUR / IRON-NATURE |
| GEWICHT / WEIGHT: | 14 KG |

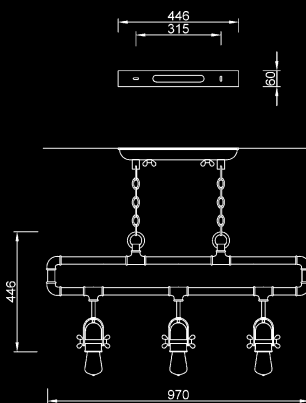

LED MULTIFILAMENT DIMMABLE





SL 109

STEHLEUCHTE / FLOOR LAMP

FASSUNG / SOCKET:

BREITE / WIDTH:

TIEFE / DEPTH:

HÖHE / HEIGHT:

OBERFLÄCHE / FINISH:

GEWICHT / WEIGHT:

1 X E 27 / 1 X E 26

360 MM / 14"

270 MM / 10,5"

1420 MM / 56"

EISEN NATUR / IRON-NATURE

15 KG

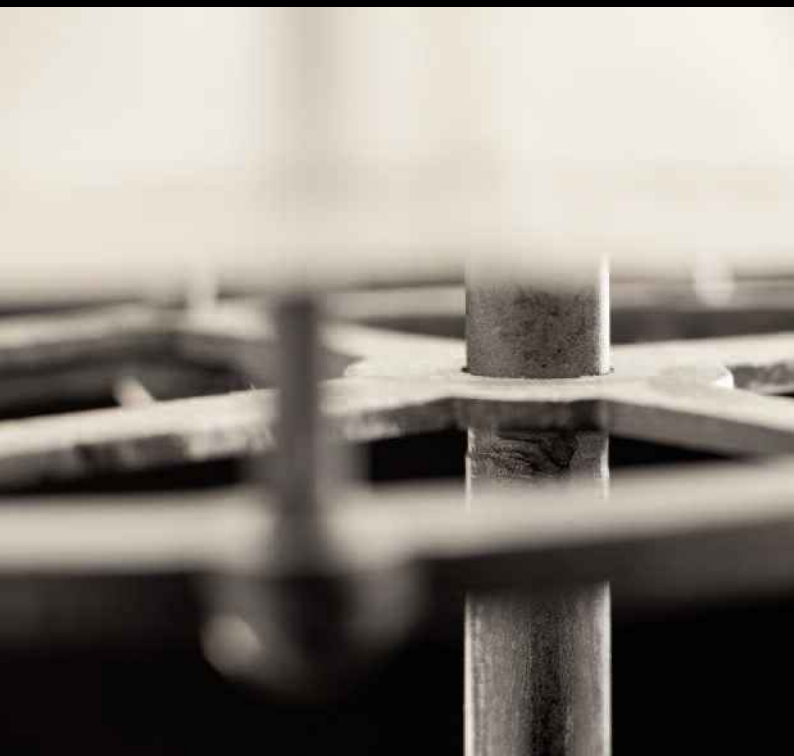

SL 109



HL 2623
HÄNGELEUCHE / SUSPENSION LAMP

| | |
|----------------------|---------------------------|
| FASSUNG / SOCKET: | 4 X E 27 / 4 X E 26 |
| BREITE / WIDTH: | 580 MM / 23" |
| HÖHE / HEIGHT: | 530 MM / 21" |
| OBERFLÄCHE / FINISH: | EISEN NATUR / IRON-NATURE |
| GEWICHT / WEIGHT: | 10 KG |

WL 3629
WANDELEUCHE / WALL LAMP

| | |
|-------------------------------|---------------------------|
| FASSUNG / SOCKET: | 1 X E 27 / 1 X E 26 |
| AUSLADUNG / DISTANCE TO WALL: | 148 MM / 6" |
| BREITE / WIDTH: | 130 MM / 5" |
| HÖHE / HEIGHT: | 264 MM / 10,5" |
| OBERFLÄCHE / FINISH: | EISEN NATUR / IRON-NATURE |
| GEWICHT / WEIGHT: | 1,8 KG |

DIE GESAMTHÖHE DER LEUCHE, INKLUSIVE AUFHÄNGUNG, WIRD IHREM WUNSCH ENTSPRECHEND GEFERTIGT.

THE OVER ALL HEIGHT OF THIS FIXTURE WILL BE MADE ACCORDING TO YOUR REQUIREMENTS.

LA HAUTEUR TOTALE DU LUMINAIRE, SYSTEME D'ATTACHE COMPRIS, SERA CONFECTIONNÉ SELON VOS SOUHAITS.

WL 3629



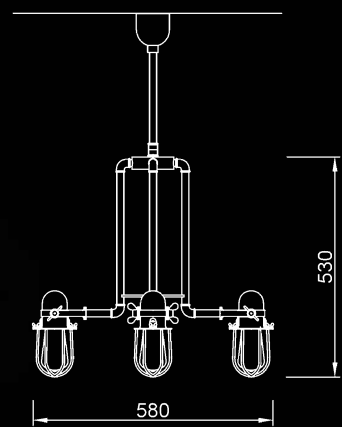

HL 2623





HL 2620



HL 2620 HÄNGELEUCHE / SUSPENSION LAMP

| | |
|----------------------|---------------------------|
| FASSUNG / SOCKET: | 1 X E 27 / 1 X E 26 |
| BREITE / WIDTH: | 122 MM / 5" |
| HÖHE / HEIGHT: | 207 MM / 8" |
| OBERFLÄCHE / FINISH: | EISEN NATUR / IRON-NATURE |
| GEWICHT / WEIGHT: | 3,4 KG |

DIE GESAMTHÖHE DER LEUCHE, INKLUSIVE AUFHÄNGUNG, WIRD IHREM WUNSCH ENTSPRECHEND GEFERTIGT.

THE OVER ALL HEIGHT OF THIS FIXTURE WILL BE MADE ACCORDING TO YOUR REQUIREMENTS.

LA HAUTEUR TOTALE DU LUMINAIRE, SYSTEME D'ATTACHE COMPRIS, SERA CONFECTIONNÉ SELON VOS SOUHAITS.

SL 108 STEHLEUCHE / FLOOR LAMP

| | |
|----------------------|---------------------------|
| FASSUNG / SOCKET: | 1 X E 27 / 1 X E 26 |
| LÄNGE / LENGTH: | 1110 MM / 44" |
| BREITE / WIDTH: | 352 MM / 14" |
| HÖHE / HEIGHT: | 1380 MM / 54" |
| OBERFLÄCHE / FINISH: | EISEN NATUR / IRON-NATURE |
| GEWICHT / WEIGHT: | 12 KG |



TL 4101 TISCHLEUCHE / TABLE LAMP

| | |
|----------------------|---------------------------|
| FASSUNG / SOCKET: | 1 X E 27 / 1 X E 26 |
| BREITE / WIDTH: | 140 MM / 5,5" |
| TIEFE / DEPTH: | 220 MM / 8,5" |
| HÖHE / HEIGHT: | 446 MM / 17,5" |
| OBERFLÄCHE / FINISH: | EISEN NATUR / IRON-NATURE |
| GEWICHT / WEIGHT: | 4 KG |



TL 4101

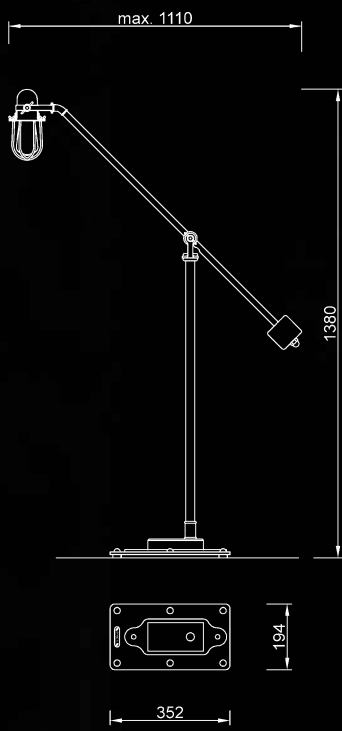

SL 108

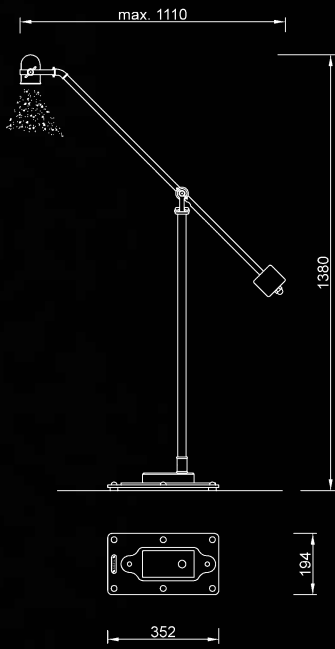

SL 110



HL 2621
HÄNGELEUCHE / SUSPENSION LAMP

FASSUNG / SOCKET: 1 X GU 10
BREITE / WIDTH: 122 MM / 5"
HÖHE / HEIGHT: 92 MM / 3,5"
OBERFLÄCHE / FINISH: EISEN NATUR / IRON-NATURE
GEWICHT / WEIGHT: 3,2 KG

DIE GESAMTHÖHE DER LEUCHE, INKLUSIVE AUFHÄNGUNG, WIRD IHREM WUNSCH ENTSPRECHEND GEFERTIGT.

THE OVER ALL HEIGHT OF THIS FIXTURE WILL BE MADE ACCORDING TO YOUR REQUIREMENTS.

LA HAUTEUR TOTALE DU LUMINAIRE, SYSTEME D'ATTACHE COMPRIS, SERA CONFECTIONNÉ SELON VOS SOUHAITS.

SL 110
STEHLEUCHE / FLOOR LAMP

FASSUNG / SOCKET: 1 X GU 10
LÄNGE / LENGTH: 1110 MM / 44"
BREITE / WIDTH: 352 MM / 14"
HÖHE / HEIGHT: 1380 MM / 54"
OBERFLÄCHE / FINISH: EISEN NATUR / IRON-NATURE
GEWICHT / WEIGHT: 12 KG



HL 2621





SL 106



HL 2609

3-FL. HÄNGELEUCHE / 3-LIGHTER SUSPENSION LAMP

| | |
|----------------------|---|
| FASSUNG / SOCKET: | 3 X E 27 / 3 X E 26 |
| LÄNGE / LENGTH: | 1400 MM / 55" |
| BREITE / WIDTH: | 200 MM / 8" |
| HÖHE / HEIGHT: | 495 MM / 19,5" |
| SCHIRME / SHADES: | KAFFEESÄCKE, MOTIVE VARIIEREN / COFFEE BAGS, THEMES MAY VARY |
| OBERFLÄCHE / FINISH: | EISEN NATUR / IRON-NATURE |
| GEWICHT / WEIGHT: | 8 KG |

DIE GESAMTHÖHE DER LEUCHE, INKLUSIVE AUFHÄNGUNG, WIRD IHREM WUNSCH ENTSPRECHEND GEFERTIGT.

THE OVER ALL HEIGHT OF THIS FIXTURE WILL BE MADE ACCORDING TO YOUR REQUIREMENTS.

LA HAUTEUR TOTALE DU LUMINAIRE, SYSTEME D'ATTACHE COMPRIS, SERA CONFECTIONNÉ SELON VOS SOUHAITS.

SL 106 STEHLEUCHE / FLOOR LAMP

| | |
|----------------------|---|
| FASSUNG / SOCKET: | 1 X E 27 / 1 X E 26 |
| LÄNGE / LENGTH: | 360 MM / 14" |
| BREITE / WIDTH: | 220 MM / 5" |
| HÖHE / HEIGHT: | 1750 MM / 69" |
| SCHIRM/SHADE: | KAFFEESACK, MOTIVE VARIIEREN / COFFEE BAG, THEMES MAY VARY |
| OBERFLÄCHE / FINISH: | EISEN NATUR / IRON-NATURE |
| GEWICHT / WEIGHT: | 15 KG |



HL 2609





SL 107



HL 2624

HL 2624

2-FL. HÄNGELEUCHTE / 2-LIGHTER SUSPENSION LAMP

| | |
|-------------------------|---------------------|
| FASSUNG / SOCKET: | 2 X E 27 / 2 X E 26 |
| LÄNGE / LENGTH: | 1200 MM / 47" |
| BREITE / WIDTH: | 400 MM / 16" |
| HÖHE / HEIGHT: | 417 MM / 16,5" |
| Ø BALDACHIN / Ø CANOPY: | 170 MM / 6,5" |
| OBERFLÄCHE / FINISH: | OLD BRONZE |
| GEWICHT / WEIGHT: | 11 KG |

DIE GESAMTHÖHE DER LEUCHTE, INKLUSIVE AUFHÄNGUNG, WIRD IHREM WUNSCH ENTSPRECHEND GEFERTIGT.

THE OVER ALL HEIGHT OF THIS FIXTURE WILL BE MADE ACCORDING TO YOUR REQUIREMENTS.

LA HAUTEUR TOTALE DU LUMINAIRE, SYSTEME D'ATTACHE COMPRIS, SERA CONFECTIONNÉ SELON VOS SOUHAITS.

SL 107

STEHLEUCHTE / FLOOR LAMP

| | |
|----------------------|---------------------------|
| FASSUNG / SOCKET: | 1 X E 27 / 1 X E 26 |
| LÄNGE / LENGTH: | 360 MM / 14" |
| BREITE / WIDTH: | 300 MM / 12" |
| HÖHE / HEIGHT: | 1750 MM / 69" |
| OBERFLÄCHE / FINISH: | EISEN NATUR / IRON-NATURE |
| GEWICHT / WEIGHT: | 16 KG |

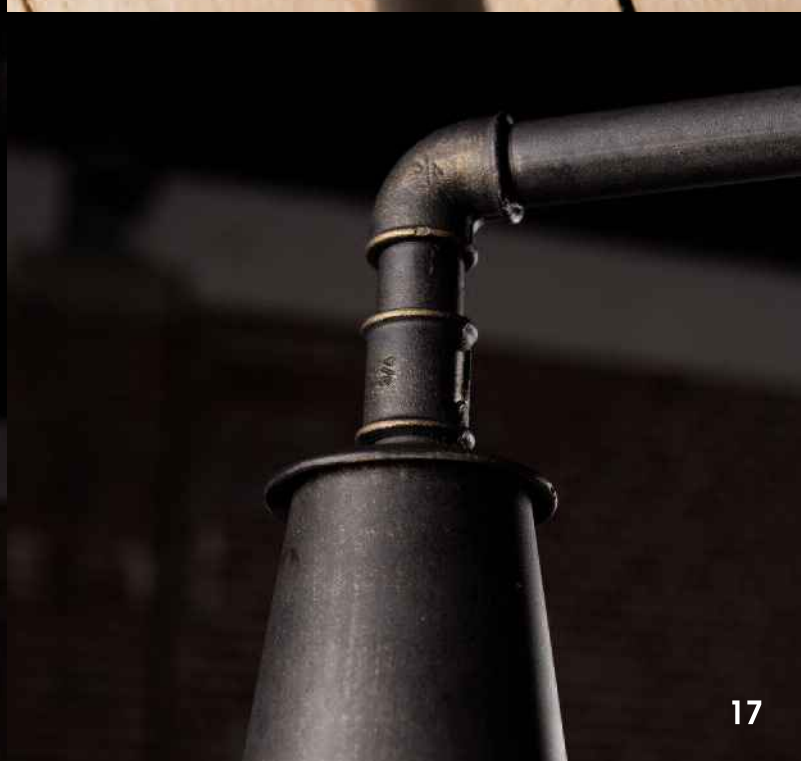



HL 2569-400 HÄNGELEUCHTE/SUSPENSION LAMP

FASSUNG / SOCKET: 1 X E 27 / 1 X E 26
 DURCHMESSER / DIAMETER: 400 MM / 15,7"
 HÖHE / HEIGHT - GEWICHT / WEIGHT: 276 MM / 11" - 4 KG
 LACKIERUNG / FINISH: EISEN NATUR / IRON-NATURE

HL 2569-500 HÄNGELEUCHTE / SUSPENSION LAMP

DURCHMESSER / DIAMETER - GEWICHT / WEIGHT: 500 MM / 20" - 6 KG

DIE GESAMTHÖHE DER LEUCHTE, INKLUSIVE AUFHÄNGUNG, WIRD IHREM WUNSCH ENTSPRECHEND GEFERTIGT.
 THE OVER ALL HEIGHT OF THIS FIXTURE WILL BE MADE ACCORDING TO YOUR REQUIREMENTS.

LA HAUTEUR TOTALE DU LUMINAIRE, SYSTEME D'ATTACHE COMPRIS, SERA CONFECTIONNÉ SELON VOS SOUHAITS.

TL 4100 TISCHLEUCHTE / TABLE LAMP

FASSUNG / SOCKET: 1 X E 27 / 1 X E 26
 HÖHE / HEIGHT: 250 MM / 10"
 DURCHMESSER / DIAMETER: 160 MM / 6"
 GLAS / GLASS: NR347 OPALWEISS / OPAL WHITE
 LACKIERUNG / FINISH: EISEN NATUR / IRON-NATURE
 GEWICHT / WEIGHT: 2 KG

KL 229 KERZENLEUCHTER / CANDLE STICK

HÖHE / HEIGHT: 90 MM / 3,5"
 DURCHMESSER / DIAMETER: 160 MM / 6"
 LACKIERUNG / FINISH: EISEN NATUR / IRON-NATURE
 GEWICHT / WEIGHT: 1 KG



TL 4100



KL 229



HL 2569-400



HL 2560
21-FL. HÄNGELEUCHE / 21-LIGHTER SUSPENSION LAMP

| | |
|-------------------------|--|
| FASSUNG / SOCKET: | 21 X E 27 / 21 X E 26 |
| MIT / WITH DOWNLIGHTS: | 3 X GU 10 |
| DURCHMESSER / DIAMETER: | 1000 MM / 39,4" |
| HÖHE / HEIGHT: | 1020 MM / 40,2" |
| GLAS / GLASS: | 9 X NR345-OM / 9 X NR346-OM / 3 X NR347-OM |
| LACKIERUNG / FINISH: | EISEN NATUR / IRON-NATURE |
| BALDACHIN / CANOPY: | B-NR 39 |
| GEWICHT / WEIGHT: | 65 KG |

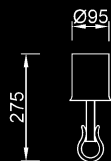

DIESE LEUCHTENSERIE KANN IN ALLEN SONDERGRÖSSEN GEFERTIGT WERDEN.
THIS PRODUCT LINE CAN BE MODIFIED IN ALL SIZES.
CETTE SÉRIE DE LUMINAIRE PEUT ÊTRE RÉALISÉE SUR MESURE.



HL 2560



WL 3576

WL 3576
WANDLEUCHTE / WALL LAMP

| | |
|-------------------------------|--|
| FASSUNG / SOCKET: | 9 X E 27 / 9 X E 26 |
| BREITE / WIDTH: | 1250 MM / 50" |
| HÖHE / HEIGHT: | 500 MM / 19,5" |
| AUSLADUNG / DISTANCE TO WALL: | 185 MM / 7,5" |
| GLAS / GLASS: | 2 X NR345-OM / 3 X NR346-OM / 4 X NR347-OM |
| LACKIERUNG / FINISH: | EISEN NATUR / IRON-NATURE |
| GEWICHT / WEIGHT: | 20 KG |

HL 2509
8-FL. HÄNGELEUCHTE / 8-LIGHTER SUSPENSION LAMP

| | |
|--------------------------|--|
| FASSUNG / SOCKET: | 8 X E 27 / 8 X E 26 |
| MIT / WITH 2 DOWNLIGHTS: | 2 x GU 10 |
| BREITE / WIDTH: | 130 MM / 5" |
| HÖHE / HEIGHT: | 270 MM / 10" |
| LÄNGE / LENGTH: | 1180 MM / 47" |
| GLAS / GLASS: | 3 X NR345-OM / 3 X NR346-OM / 2 X NR347-OM |
| LACKIERUNG / FINISH: | EISEN NATUR / IRON-NATURE |
| GEWICHT / WEIGHT: | 18 KG |



HL 2509





WL 3484

WL 3484 WANDLEUCHTE / WALL LAMP

| | |
|-------------------------------|---------------------|
| FASSUNG / SOCKET: | 1 X E 27 / 1 X E 26 |
| BREITE / WIDTH: | 165 MM / 6" |
| HÖHE / HEIGHT: | 335 MM / 13" |
| AUSLADUNG / DISTANCE TO WALL: | 185 MM / 7" |
| GLAS / GLASS: | 1 X NR347-OM |
| LACKIERUNG / FINISH: | OLD BLACK |
| GEWICHT / WEIGHT: | 3,8 KG |

WL 3484-ST WANDLEUCHTE / WALL LAMP

| | |
|-------------------------------|-------------------------------------|
| FASSUNG / SOCKET: | 1 X E 27 + GU 10 / 1 X E 26 + GU 10 |
| BREITE / WIDTH: | 165 MM / 6" |
| HÖHE / HEIGHT: | 335 MM / 13" |
| AUSLADUNG / DISTANCE TO WALL: | 185 MM / 7" |
| GLAS / GLASS: | 1X NR347-OM |
| LACKIERUNG / FINISH: | PATINA |
| GEWICHT / WEIGHT: | 4,8 KG |

WL 3603 WANDLEUCHTE / WALL LAMP

| | |
|-------------------------------|---|
| FASSUNG / SOCKET: | 3 X E 27 + 1 X GU 10 / 3 X E 26 + 1 X GU 10 |
| BREITE / WIDTH: | 387 MM / 15" |
| HÖHE / HEIGHT: | 335 MM / 13" |
| AUSLADUNG / DISTANCE TO WALL: | 185 MM / 7" |
| GLAS / GLASS: | 1 X NR345-OM / 1 X NR346-OM / 1 X NR347-OM |
| LACKIERUNG / FINISH: | PATINA |
| GEWICHT / WEIGHT: | 11 KG |



WL 3484-ST



WL 3603

WL 3625 WANDLEUCHE / WALL LAMP

| | |
|-------------------------------|---------------------------|
| FASSUNG / SOCKET: | 1 X E 27 / 1 X E 26 |
| AUSLADUNG / DISTANCE TO WALL: | 220 MM / 8,5" |
| BREITE / WIDTH: | 100 MM / 4" |
| HÖHE / HEIGHT: | 1300 MM / 51,2" |
| GLAS / GLASS: | NR346-OM |
| LACKIERUNG / FINISH: | EISEN NATUR / IRON-NATURE |
| GEWICHT / WEIGHT: | 6,4 KG |

SL 105 STEHLEUCHE / FLOOR LAMP

| | |
|----------------------|---------------------------|
| FASSUNG / SOCKET: | 2 X E 27 / 2 X E 26 |
| BREITE / WIDTH: | 410 MM / 16" |
| HÖHE / HEIGHT: | 1840 MM / 72,5" |
| GLAS / GLASS: | NR346-OM |
| LACKIERUNG / FINISH: | EISEN NATUR / IRON-NATURE |
| GEWICHT / WEIGHT: | 20 KG |

TL 4102 TISCHLEUCHE / TABLE LAMP

| | |
|----------------------|---------------------------|
| FASSUNG / SOCKET: | 1 X E 27 / 1 X E 26 |
| BREITE / WIDTH: | 300 MM / 12" |
| HÖHE / HEIGHT: | 676 MM / 26,5" |
| GLAS / GLASS: | NR346-OM |
| LACKIERUNG / FINISH: | EISEN NATUR / IRON-NATURE |
| GEWICHT / WEIGHT: | 9 KG |



SL 105



TL 4102



WL 3625



WL 3616



WL 3616
WANDLEUCHTE / WALL LAMP

| | |
|-------------------------------|--------------------------------|
| FASSUNG / SOCKET: | 1 X E 27/1 X E 26 |
| BREITE / WIDTH: | 136 MM / 5,3" |
| HÖHE / HEIGHT: | 390 MM / 15,4" |
| AUSLADUNG / DISTANCE TO WALL: | 125 MM / 5" |
| GLAS / GLASS: | NR285 OPAL MATT / OPAL FROSTED |
| LACKIERUNG / FINISH: | EISEN NATUR / IRON-NATURE |
| GEWICHT / WEIGHT: | 3,5 KG |





HL 2557

HL 2557

6-FL. HÄNGELEUCHE / 6-LIGHTER SUSPENSION LAMP

| | |
|-------------------------|---------------------------|
| FASSUNG / SOCKET: | 6 X E 27 / 6 X E 26 |
| MIT / WITH DOWNLIGHTS: | 3 X GU 10 |
| DURCHMESSER / DIAMETER: | 700 MM / 27,5" |
| HÖHE / HEIGHT: | 270 MM / 10,5" |
| GLAS / GLASS: | NR285-OM |
| LACKIERUNG / FINISH: | EISEN NATUR / IRON-NATURE |
| GEWICHT / WEIGHT: | 19 KG |

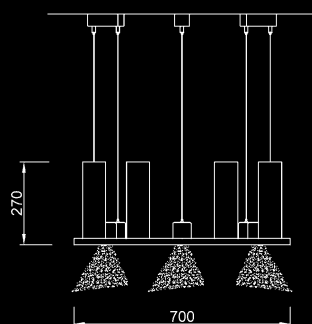



WL 3582



WL 3583

WL 3583
WANDLEUCHE / WALL LAMP

| | |
|-------------------------------|--------------------------------|
| FASSUNG / SOCKET: | 3 X E 27 / 3 X E 26 |
| BREITE / WIDTH: | 495 MM / 19,5" |
| HÖHE / HEIGHT: | 630 MM / 25" |
| AUSLADUNG / DISTANCE TO WALL: | 130 MM / 5" |
| GLAS / GLASS: | NR285 OPAL MATT / OPAL FROSTED |
| LACKIERUNG / FINISH: | EISEN NATUR / IRON-NATURE |
| GEWICHT / WEIGHT: | 9,3 KG |

WL 3582
WANDLEUCHE / WALL LAMP

| | |
|-------------------------------|--------------------------------|
| FASSUNG / SOCKET: | 1 X E 27 / 1 X E 26 |
| BREITE / WIDTH: | 125 MM / 5" |
| HÖHE / HEIGHT: | 630 MM / 25" |
| AUSLADUNG / DISTANCE TO WALL: | 130 MM / 5" |
| GLAS / GLASS: | NR285 OPAL MATT / OPAL FROSTED |
| LACKIERUNG / FINISH: | EISEN NATUR / IRON-NATURE |
| GEWICHT / WEIGHT: | 3 KG |



HL 2555

HL 2555

5-FL. HÄNGELEUCHE / 5-LIGHTER SUSPENSION LAMP

| | |
|--------------------------|--------------------------------|
| FASSUNG / SOCKET: | 5 X E 27 / 5 X E 26 |
| MIT / WITH 2 DOWNLIGHTS: | 2 X GU 10 |
| BREITE / WIDTH: | 130 MM / 5" |
| HÖHE / HEIGHT: | 268 MM / 10,5" |
| LÄNGE / LENGTH: | 1275 MM / 49,5" |
| GLAS / GLASS: | NR285 OPAL MATT / OPAL FROSTED |
| LACKIERUNG / FINISH: | EISEN NATUR / IRON-NATURE |
| GEWICHT / WEIGHT: | 14 KG |

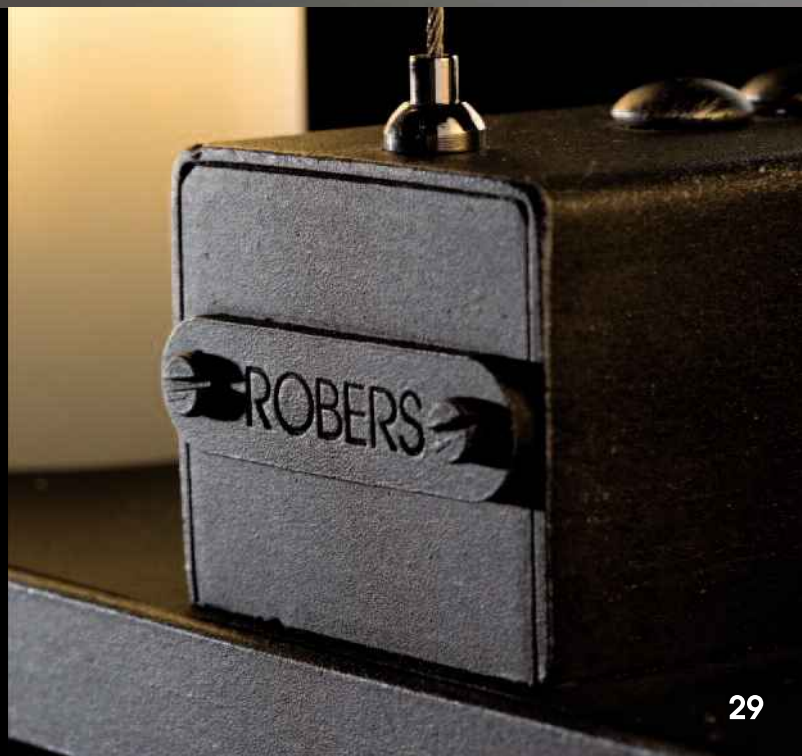
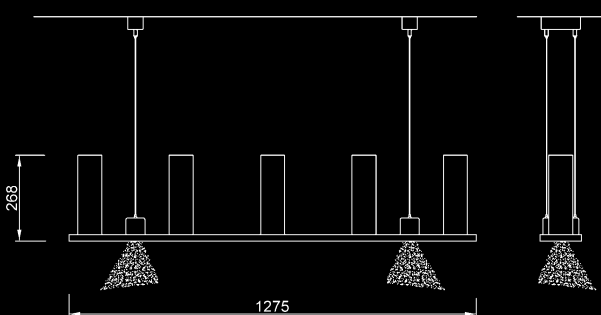



HL 2547



HL 2547

HL 2547

5-FL. HÄNGELEUCHE / 5-LIGHTER SUSPENSION LAMP

| | |
|------------------------|--------------------------------|
| FASSUNG / SOCKET: | 5 X E 27 / 5 X E 26 |
| MIT / WITH DOWNLIGHTS: | 3 X GU 10 |
| BREITE / WIDTH: | 100 MM / 4" |
| HÖHE / HEIGHT: | 363 MM / 14" |
| LÄNGE / LENGTH: | 1300 MM / 51" |
| GLAS / GLASS: | NR411 OPAL MATT / OPAL FROSTED |
| LACKIERUNG / FINISH: | EISEN NATUR / IRON-NATURE |
| GEWICHT / WEIGHT: | 33 KG |

DIE GESAMTHÖHE DER LEUCHE, INKLUSIVE AUFHÄNGUNG, WIRD IHREM WUNSCH ENTSPRECHEND GEFERTIGT.

THE OVER ALL HEIGHT OF THIS FIXTURE WILL BE MADE ACCORDING TO YOUR REQUIREMENTS.

LA HAUTEUR TOTALE DU LUMINAIRE, SYSTEME D'ATTACHE COMPRIS, SERA CONFECTIONNÉ SELON VOS SOUHAITS.



WL 3580

WL 3580

WANDLEUCHE / WALL LAMP

| | |
|-------------------------------|--------------------------------|
| FASSUNG / SOCKET: | 1 X E 27 / 1 X E 26 |
| BREITE / WIDTH: | 125 MM / 5" |
| HÖHE / HEIGHT: | 700 MM / 27.5" |
| AUSLADUNG / DISTANCE TO WALL: | 120 MM / 5" |
| GLAS / GLASS: | NR411 OPAL MATT / OPAL FROSTED |
| LACKIERUNG / FINISH: | EISEN NATUR / IRON-NATURE |
| GEWICHT / WEIGHT: | 5.5 KG |



WL 3581

WL 3581

WANDKERZENHALTER INKLUSIV ALTARKERZEN / WALL CANDLE STICK INCL. CHURCH CANDLES

| | |
|-------------------------------|---------------------------|
| BREITE / WIDTH: | 720 MM / 28.3" |
| HÖHE / HEIGHT: | 700 MM / 27.5" |
| AUSLADUNG / DISTANCE TO WALL: | 100 MM / 4" |
| LACKIERUNG / FINISH: | EISEN NATUR / IRON-NATURE |
| GEWICHT / WEIGHT: | 30 KG |



B 8674



HL 2548

HL 2548

8-FL HÄNGELEUCHE / 8-LIGHTER SUSPENSION LAMP

| | |
|-------------------------|---------------------------------|
| FASSUNG / SOCKET: | 8 X E 27 / 8 X E 26 + 4 X GU 10 |
| DURCHMESSER / DIAMETER: | 1000 MM / 39" |
| HÖHE / HEIGHT: | 363 MM / 14" |
| GLAS / GLASS: | NR411 OPAL MATT / OPAL FROSTED |
| LACKIERUNG / FINISH: | EISEN NATUR / IRON-NATURE |
| GEWICHT / WEIGHT: | 75 KG |

DIE GESAMTHÖHE DER LEUCHE, INKLUSIVE AUFHÄNGUNG, WIRD IHREM WUNSCH ENTSPRECHEND GEFERTIGT. DIE LEUCHE KANN AUCH IN GRÖßEREN DURCHMESSERN ALS 1000MM GEFERTIGT WERDEN.

THE OVER ALL HEIGHT OF THIS FIXTURE WILL BE MADE ACCORDING TO YOUR REQUIREMENTS. IT IS ALSO POSSIBLE TO MAKE THIS FIXTURE BIGGER IN DIAMETER.

LA HAUTEUR TOTALE DU LUMINAIRE, SYSTEME D'ATTACHE COMPRIS, SERA CONFECTIONNÉ SELON VOS SOUHAITS. CE LUMINAIRE PEUT AUSSI ÊTRE FABRIQUÉ AVEC UN DIAMÈTRE SUPÉRIEUR À 1000MM.

B 8674 BLUMENAMPEL / FLOWER BOARD

| | |
|-------------------------------|---------------------------|
| BREITE / WIDTH: | 125 MM/5" |
| HÖHE / HEIGHT: | 1675 MM/66" |
| AUSLADUNG / DISTANCE TO WALL: | 90 MM/3,5" |
| GLAS / GLASS: | NR449 KLAR |
| LACKIERUNG / FINISH: | EISEN ROSTIG / IRON-RUSTY |
| GEWICHT / WEIGHT: | 11 KG |

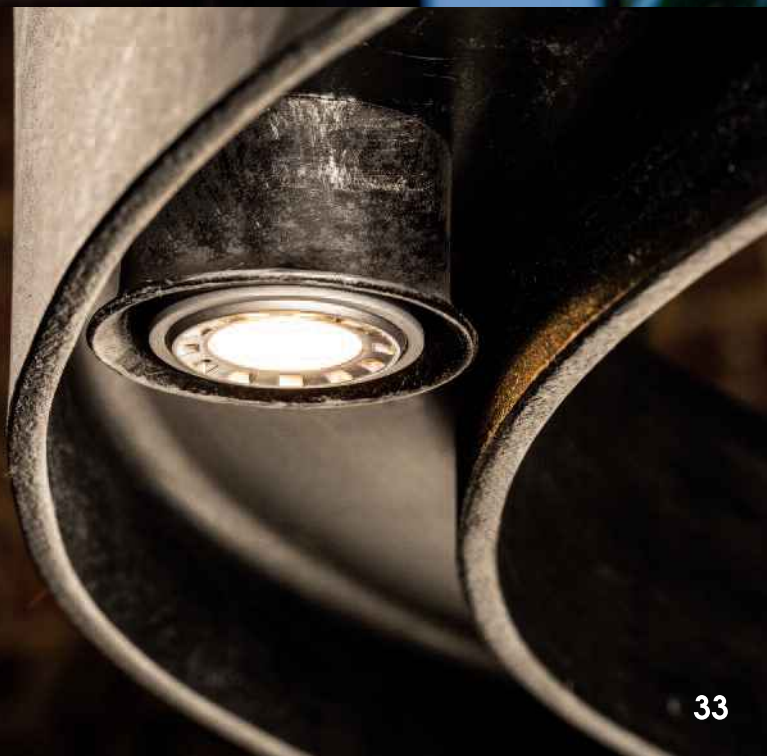



WL 3639



WL 3639

15-FL. WANDLEUCHTE / 15-LIGHTER WALL LAMP

| | |
|-------------------------------|--|
| FASSUNG / SOCKET: | 15 X E 27 / 15 X E 26 |
| BREITE / WIDTH: | 2065 MM / 81" |
| HÖHE / HEIGHT: | 500 MM / 20" |
| AUSLADUNG / DISTANCE TO WALL: | 185 MM / 7.3" |
| GLAS / GLASS: | 4 X NR345-OM / 4 X NR346-OM / 7 X NR347-OM |
| LACKIERUNG / FINISH: | EISEN ROSTIG / IRON-RUSTY |
| GEWICHT / WEIGHT: | 58 KG |

HL 33.000.078-B

27-FL. HÄNGELEUCHE / 27-LIGHTER SUSPENSION LAMP

| | |
|----------------------|--|
| FASSUNG / SOCKET: | 27 X E 27 / 27 X E 26 + 9 X GU 10 |
| BREITE / WIDTH: | 186 MM / 7" |
| HÖHE / HEIGHT: | 320 MM / 12.5" |
| LÄNGE / LENGTH: | 9000 MM / 355" |
| GLAS / GLASS: | 9 X NR388-OM / 9 X NR346-OM / 9 X NR347-OM |
| OBERFLÄCHE / FINISH: | EISEN NATUR / IRON-NATURE |
| GEWICHT / WEIGHT: | 318 KG |

DIE GESAMTHÖHE DER LEUCHE, INKLUSIVE AUFHÄNGUNG, WIRD IHREM WUNSCH ENTSPRECHEND GEFERTIGT.
 THE OVER ALL HEIGHT OF THIS FIXTURE WILL BE MADE ACCORDING TO YOUR REQUIREMENTS.
 LA HAUTEUR TOTALE DU LUMINAIRE, SYSTEME D'ATTACHE COMPRIS, SERA CONFECTIONNÉ SELON VOS SOUHAITS.



33.000.078-B

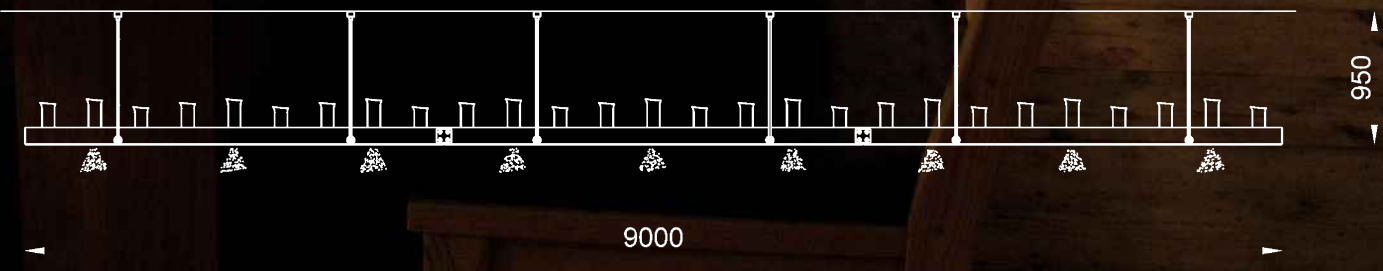
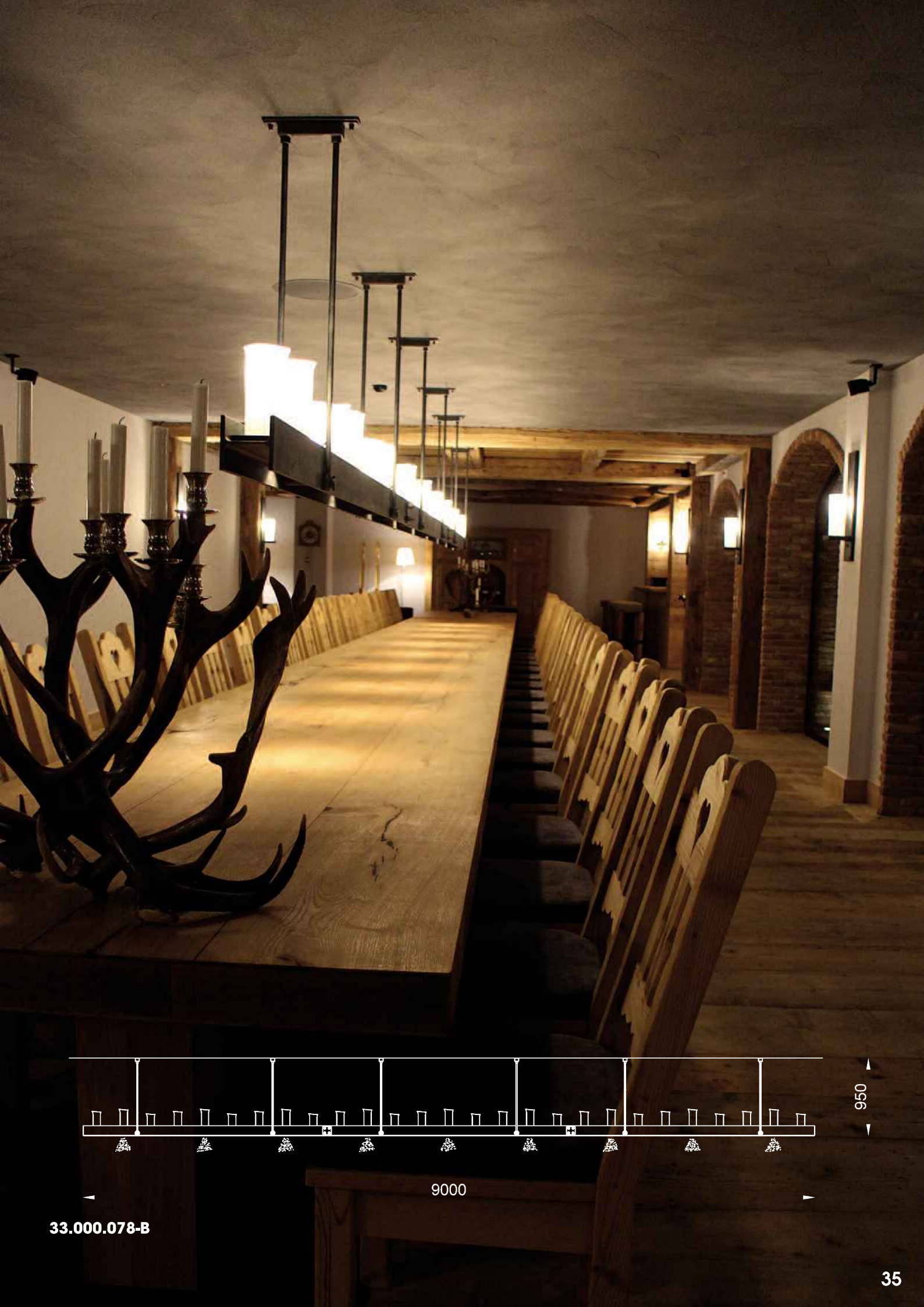

33.000.078-B



DE 2627



DE 2626 DECKENLEUCHTE / CEILING LAMP

OHNE ABBILDUNG / WITHOUT PICTURE

FASSUNG / SOCKET: 2 X E 27 / 2 X E 26
BREITE / WIDTH: 420 MM / 16,5"
HÖHE / HEIGHT: 120 MM / 5"
GLAS / GLASS: NR320 OPALWEISS / OPAL WHITE
LACKIERUNG / FINISH: TERRA
GEWICHT / WEIGHT: 10 KG

DE 2627 DECKENLEUCHTE / CEILING LAMP

FASSUNG / SOCKET: 3 X E 27 / 3 X E 26
BREITE / WIDTH: 540 MM / 21"
HÖHE / HEIGHT: 135 MM / 5"
GLAS / GLASS: NR321 OPALWEISS / OPAL WHITE
LACKIERUNG / FINISH: TERRA
GEWICHT / WEIGHT: 14,2 KG

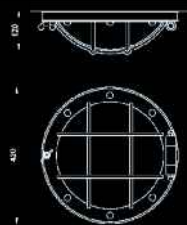

DE 2626

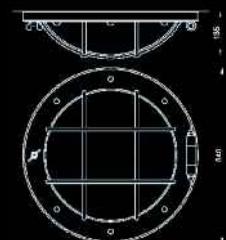

DE 2627



ST 2619

ST 2619
STRAHLER / SPOT

| | |
|-------------------------------|---------------------------|
| FASSUNG / SOCKET: | GU 10 |
| BREITE / WIDTH: | 130 MM / 5" |
| AUSLADUNG / DISTANCE TO WALL: | 128 MM / 5" |
| HÖHE / HEIGHT: | 130 MM / 5" |
| LACKIERUNG / FINISH: | EISEN NATUR / IRON-NATURE |
| GEWICHT / WEIGHT: | 1,2 KG |

ST 2615 STRAHLER / SPOT

| | |
|----------------------|---------------------------|
| FASSUNG / SOCKET: | GU 10 |
| BREITE / WIDTH: | 150 MM / 6" |
| HÖHE / HEIGHT: | 90 MM / 3,5" |
| LACKIERUNG / FINISH: | EISEN NATUR / IRON-NATURE |
| GEWICHT / WEIGHT: | 1 KG |

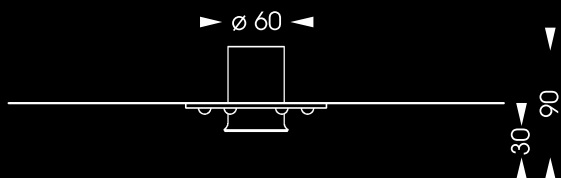

ST 2615



DE 2550



DE 2551



DE 2552

DE 2550 DECKENLEUCHTE / CEILING LAMP

FASSUNG / SOCKET: 2 X E 27 / 2 X E 26
HÖHE / HEIGHT: 120 MM / 5"
DURCHMESSER / DIAMETER: 420 MM / 16.5"
GLAS / GLASS: NR320 OPAL MATT / FROSTED
LACKIERUNG / FINISH: EISEN NATUR / IRON-NATURE
GEWICHT / WEIGHT: 8 KG

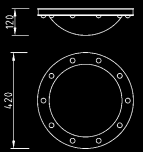

DE 2551 DECKENLEUCHTE / CEILING LAMP

FASSUNG / SOCKET: 3 X E 27 / 3 X E 26
HÖHE / HEIGHT: 135 MM / 5.5"
DURCHMESSER / DIAMETER: 540 MM / 21"
GLAS / GLASS: NR321 OPAL MATT / FROSTED
LACKIERUNG / FINISH: EISEN NATUR / IRON-NATURE
GEWICHT / WEIGHT: 10 KG

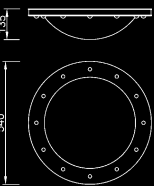

DE 2552 DECKENLEUCHTE / CEILING LAMP

FASSUNG / SOCKET: 3 X E 27 / 3 X E 26
HÖHE / HEIGHT: 155 MM / 6"
DURCHMESSER / DIAMETER: 730 MM / 29"
GLAS / GLASS: NR322 OPAL MATT / FROSTED
LACKIERUNG / FINISH: EISEN NATUR / IRON-NATURE
GEWICHT / WEIGHT: 14 KG

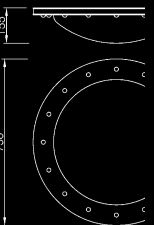

DE 2551
TERRA



ST 2628

ST 2628 STRAHLERLEISTE / SPOT RAIL

| | |
|----------------------|---------------------------|
| FASSUNG / SOCKET: | 3 X E 27 / 3 X E 26 |
| LÄNGE / LENGTH: | 730 MM / 29" |
| BREITE / WIDTH: | 150 MM / 6" |
| HÖHE / HEIGHT: | 90 MM / 3,5" |
| LACKIERUNG / FINISH: | EISEN NATUR / IRON-NATURE |
| GEWICHT / WEIGHT: | 8,4 KG |

ST 2614 STRAHLER / SPOT

| | |
|-------------------------------|---------------------------|
| FASSUNG / SOCKET: | 1 X E 27 / 1 X E 26 |
| BREITE / WIDTH: | 120 MM / 5" |
| HÖHE / HEIGHT: | 200 MM / 8" |
| AUSLADUNG / DISTANCE TO WALL: | 180 MM / 7" |
| LACKIERUNG / FINISH: | EISEN NATUR / IRON-NATURE |
| GEWICHT / WEIGHT: | 2,2 KG |

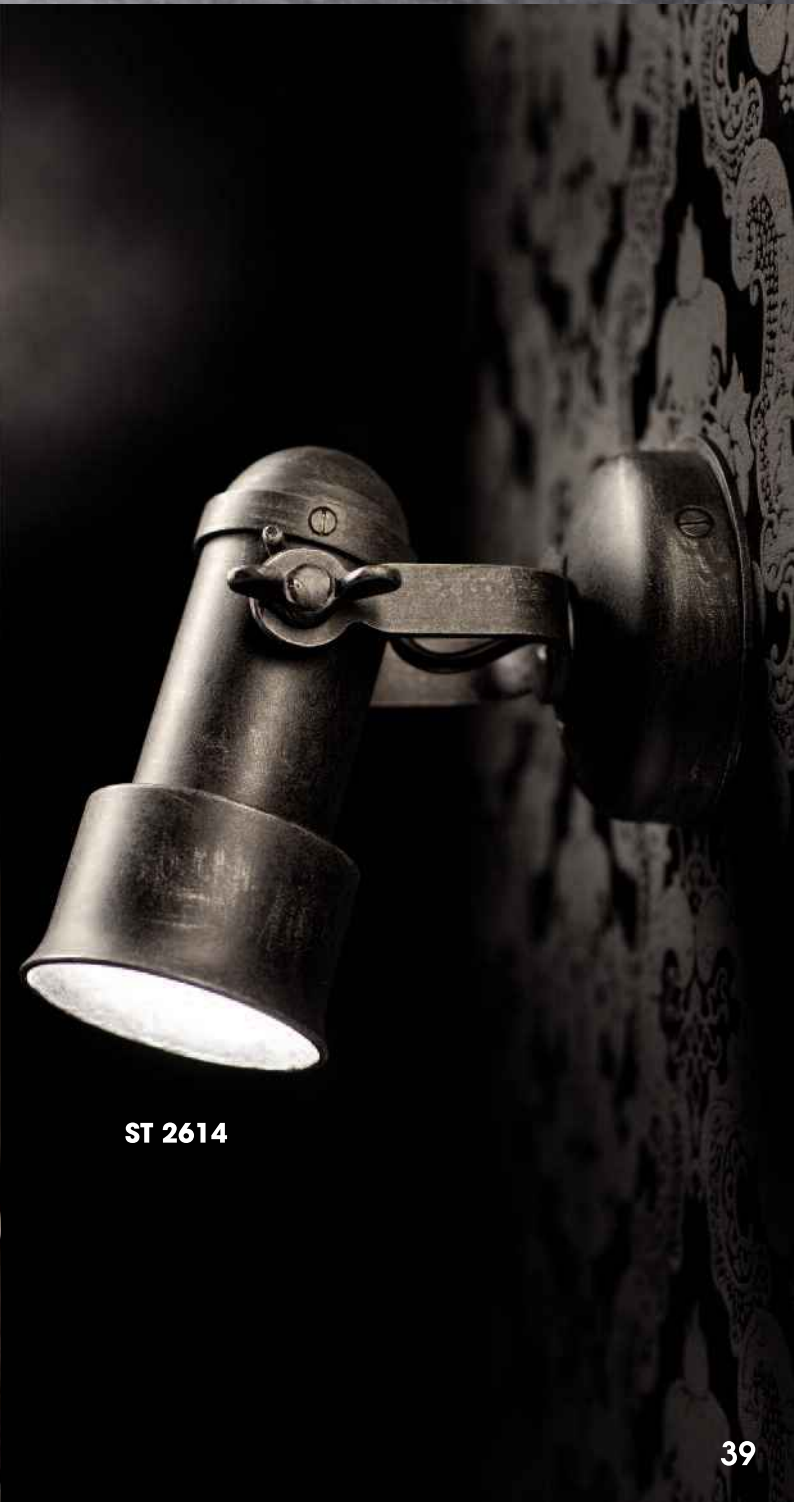

ST 2614

H 16930
SCHRANK / CABINET

BREITE / WIDTH: 900 MM / 35.5"
TIEFE / DEPTH: 500 MM / 20"
HÖHE / HEIGHT: 1260 MM / 50"
LACKIERUNG / FINISH: EISEN NATUR / IRON-NATURE
HOLZ / WOOD: EICHE GEÖLT / OILED OAK
GEWICHT / WEIGHT: 108 KG

H 16931
THEKE / COUNTER

LÄNGE / LENGTH: 1580 MM / 62"
BREITE / WIDTH: 830 MM / 33"
HÖHE / HEIGHT INCL. LEUCHTE / LAMP: 2280 MM / 90"
HÖHE THEKE / HEIGHT COUNTER: 1150 MM / 45"
LACKIERUNG / FINISH: EISEN NATUR / IRON-NATURE
HOLZ / WOOD: EICHE GEÖLT / OILED OAK
GEWICHT / WEIGHT: 200 KG

DIE ROBUSTE OPTIK DER MÖBEL IST GEWOLLT. AUFGRUND DES NATÜRLICHEN EICHENHOLZES ERGEBEN SICH UNGLEICHMÄSSIGKEITEN, DIE DEN CHARME DER MÖBEL AUSMACHEN.

BECAUSE WE WANT TO RECEIVE A VERY RUGGED LOOK WE USE REAL OAKWOOD. THEREFORE WE HAVE DIFFERENCES IN COLOUR AND SURFACES WHICH OF CAUSE MAKES THE CHARM OF IT.

L'UTILISATION DU CHÊNE DANS LA FABRICATION DE NOS MEUBLES LEUR APORTE SOLIDITÉ, ESTHÉTISME ET CHARME.



H 16931

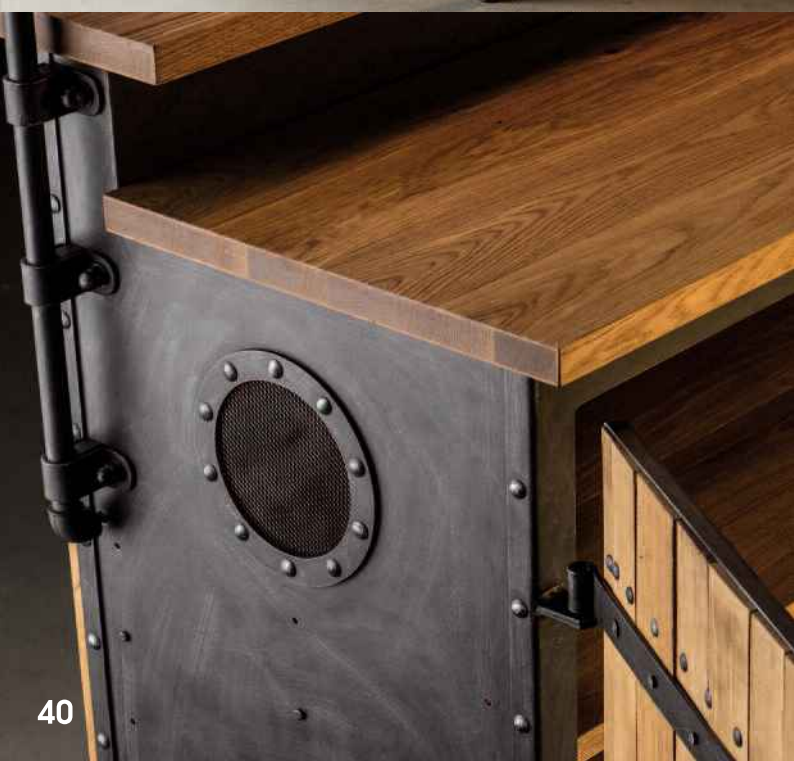



H 16930

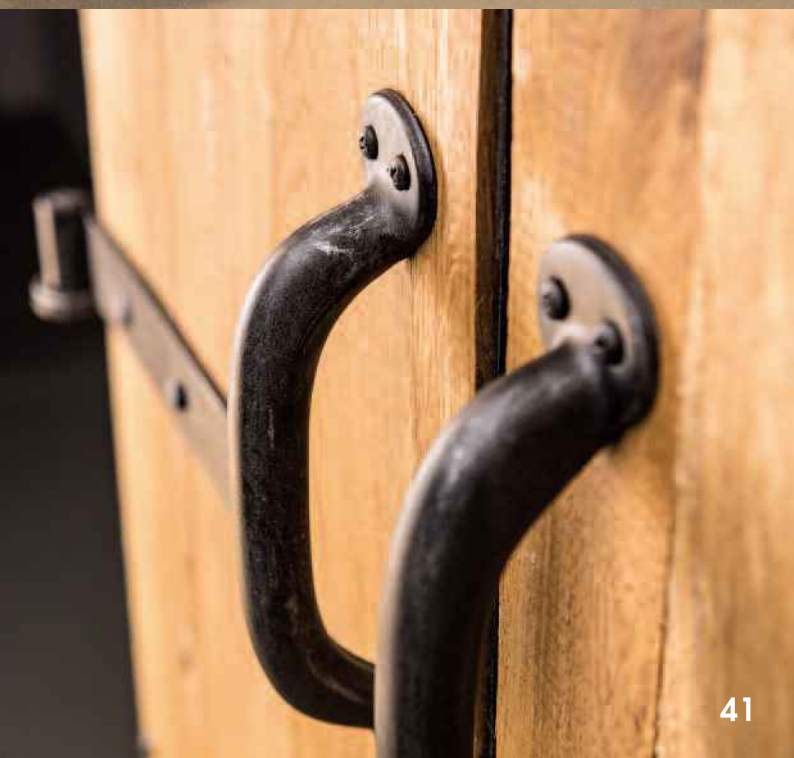



H 16928
COUCHTISCH / COFFEE TABLE

BREITE / WIDTH:

700 MM / 27.5"

HÖHE / HEIGHT:

400 MM / 16"

LÄNGE / LENGTH:

1200 MM / 47"

HOLZ / WOOD:

EICHE GEÖLT / OILED OAK

LACKIERUNG / FINISH:

TERRA

GEWICHT / WEIGHT:

60 KG



H 16928



H 16927

H 16927
COUCHTISCH / COFFEE TABLE

BREITE / WIDTH:

725 MM / 28,5"

HÖHE / HEIGHT:

513 MM / 20,5"

LÄNGE / LENGTH:

1225 MM / 48"

HOLZ / WOOD:

EICHE GEÖLT / OILED OAK

LACKIERUNG / FINISH:

OLD COPPER

GEWICHT / WEIGHT:

65 KG







H 16929

H 16929
SERVIERTISCH / WINE COUNTER

| | |
|----------------------|---------------------------|
| LÄNGE / LENGTH: | 1200 MM / 47" |
| BREITE / WIDTH: | 500 MM / 20" |
| HÖHE / HEIGHT: | 1100 MM / 43,5" |
| LACKIERUNG / FINISH: | EISEN NATUR / IRON-NATURE |
| HOLZ / WOOD: | EICHE / OAK |
| GEWICHT / WEIGHT: | 142 KG |

AUF SEITE 44 SEHEN SIE EINEN NACH KUNDENWUNSCH VON UNS AUSGESTATTETEN WEINKELLER INKL. LED-BELEUCHTUNG.

ON PAGE 44 YOU SEE A WINE CELLAR WITH CUSTOM MADE EQUIPMENT FROM ROBERS INCL. LED BACKLIGHTING.

À LA PAGE 44, DÉCOUVREZ UNE CAVE À VIN RÉALISÉE SUR MESURE AVEC DU MOBILIER ROBERS INCLUANT UN SYSTÈME D'ÉCLAIRAGE À LED.



*Le Bistrot
Gourmand*
Remerschen





Le Bistrot Gourmand Luxembourg

LEUCHTEN IN SONDERANFERTIGUNGEN FÜR EIN RESTAURANT.

CUSTOM LIGHTING FIXTURES FOR A RESTAURANT.

LAMPES FAITS SUR MESURE POUR UN RESTAURANT.

33.000.087-AI

HÄNGELEUCHE / SUSPENSION LAMP

FASSUNG / SOCKET: 1 X E 27 / 1 X E 26 + GU 10
 DURCHMESSER / DIAMETER: 180 MM / 7"
 HÖHE / HEIGHT: 900 MM / 35"
 GLAS / GLASS: 1 X NR333-OM
 OBERFLÄCHE / FINISH: EISEN NATUR / IRON-NATURE

33.000.087-BI

WANDLEUCHE / WALL LAMP

FASSUNG / SOCKET: 3 X E 27 / 3 X E 26
 BREITE / WIDTH: 160 MM / 6,5"
 HÖHE / HEIGHT: 1300 MM / 51"
 AUSLADUNG / DISTANCE TO WALL: 180 MM / 7"
 GLAS / GLASS: 3 X NR116-OM
 OBERFLÄCHE / FINISH: EISEN NATUR / IRON-NATURE





H 16922

H 16922
GLASTISCH / GLASS TABLE

| | |
|----------------------|---------------------------|
| BREITE / WIDTH: | 500 MM / 20" |
| HÖHE / HEIGHT: | 512 MM / 20,5" |
| LÄNGE / LENGTH: | 980 MM / 38,5" |
| LACKIERUNG / FINISH: | EISEN NATUR / IRON-NATURE |
| GEWICHT / WEIGHT: | 50 KG |



H 16933

H 16933
TISCH MIT LEUCHTE / ILLUMINATED TABLE

| | |
|-------------------------------------|---------------------------|
| FASSUNG / SOCKET: | 1 X E 27 / 1 X E 26 |
| LÄNGE / LENGTH: | 800 MM / 31,5" |
| BREITE / WIDTH: | 800 MM / 31,5" |
| HÖHE / HEIGHT INCL. LEUCHTE / LAMP: | 1850 MM / 73" |
| HÖHE TISCH / HEIGHT TABLE: | 760 MM / 30" |
| LACKIERUNG / FINISH: | EISEN NATUR / IRON-NATURE |
| HOLZ / WOOD: | EICHE GEÖLT / OILED OAK |
| GEWICHT / WEIGHT: | 66 KG |



KL 229



H 16932

H 16932
TISCH / TABLE

LÄNGE / LENGTH: 800 MM / 31,5"
BREITE / WIDTH: 800 MM / 31,5"
HÖHE / HEIGHT: 760 MM / 30"
LACKIERUNG / FINISH: EISEN NATUR / IRON-NATURE
HOLZ / WOOD: EICHE GEÖLT / OILED OAK
GEWICHT / WEIGHT: 54 KG

KL 229 KERZENLEUCHTER / CANDLE STICK

HÖHE / HEIGHT: 90 MM / 3,5"
DURCHMESSER / DIAMETER: 160 MM / 6"
LACKIERUNG / FINISH: EISEN NATUR / IRON-NATURE
GEWICHT / WEIGHT: 1 KG





DETAILS DER INNENEINRICHTUNG FÜR DAS CAFÉ RESTAURANT PRALINENMANUFAKTUR „TURMHAUS“ IN SÜDLOHN. LACKIERUNG EISEN NATUR

DETAILS FOR THE INTERIOR OF THE CAFÉ RESTAURANT CHOCOLATE MANUFACTURE „TURMHAUS“ IN SÜDLOHN-GERMANY. FINISH: IRON-NATURE

DÉTAILS DE L'INTÉRIEUR DU CAFÉ-RESTAURANT ET MANUFACTURE DE CHOCOLAT « TURMHAUS » À SUDLOHN. FINITION EISEN-NATUR

WWW.TURMHAUS.COM

TREPPENGELÄNDER UND HÄNGELEUCHE FÜR DAS AUSFLUGSLOKAL RESTAURANT „HAARMÜHLE“ IN AHAUS.

BANISTER AND SUSPENSION LAMP FOR THE POPULAR RESTAURANT „HAARMÜHLE“ IN AHAUS-GERMANY.

BALUSTRADE ET LAMPE DE SUSPENSION POUR LE POPULAIRE RESTAURANT « HAARMUEHLE » À AHAUS EN ALLEMAGNE.

WWW.HAARMUEHLE.DE

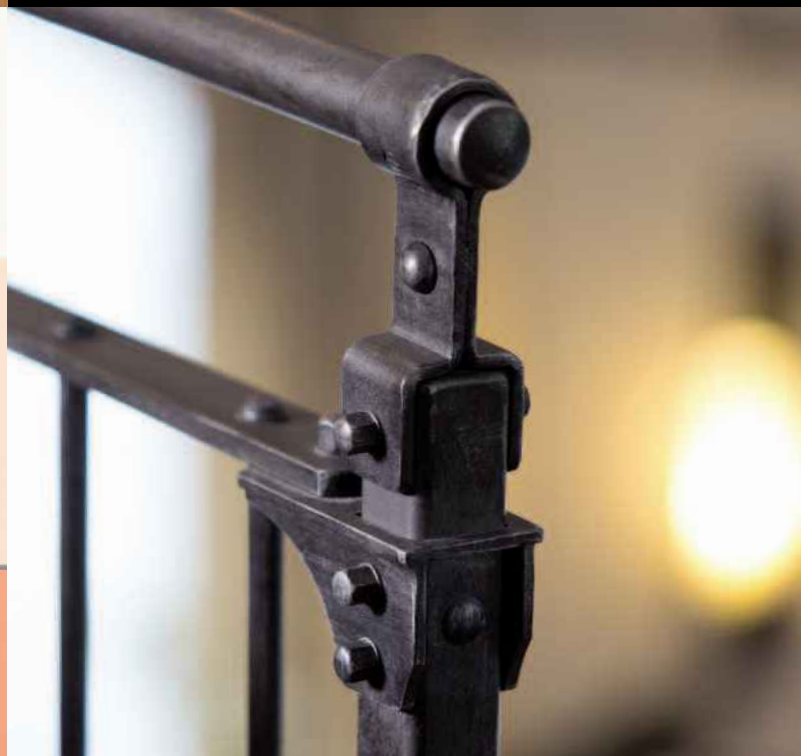





GARDEROBE 8.883.000



B 8702

GARDEROBE / WARDROBE

ABMESSUNGEN NACH KUNDENWUNSCH.
DIMENSIONS UPON REQUEST.
DIMENSION FAIT SUR MESURE.

B 8702

SCHIRMSTÄNDER/UMBRELLA STAND

| | |
|----------------------|---------------------------|
| BREITE / WIDTH: | 308 MM / 12" |
| HÖHE / HEIGHT: | 565 MM / 22" |
| LACKIERUNG / FINISH: | EISEN NATUR / IRON NATURE |
| GEWICHT / WEIGHT: | 14,2 KG |

B 8708

GROSSE WANDUHR / BIG WALL CLOCK

| | |
|-------------------------------|---------------------------|
| BREITE / WIDTH: | 960 MM / 38" |
| HÖHE / HEIGHT: | 960 MM / 38" |
| AUSLADUNG / DISTANCE TO WALL: | 32 MM / 1,5" |
| LACKIERUNG / FINISH: | EISEN ROSTIG / IRON-RUSTY |
| GEWICHT / WEIGHT: | 16,2 KG |





B 8708

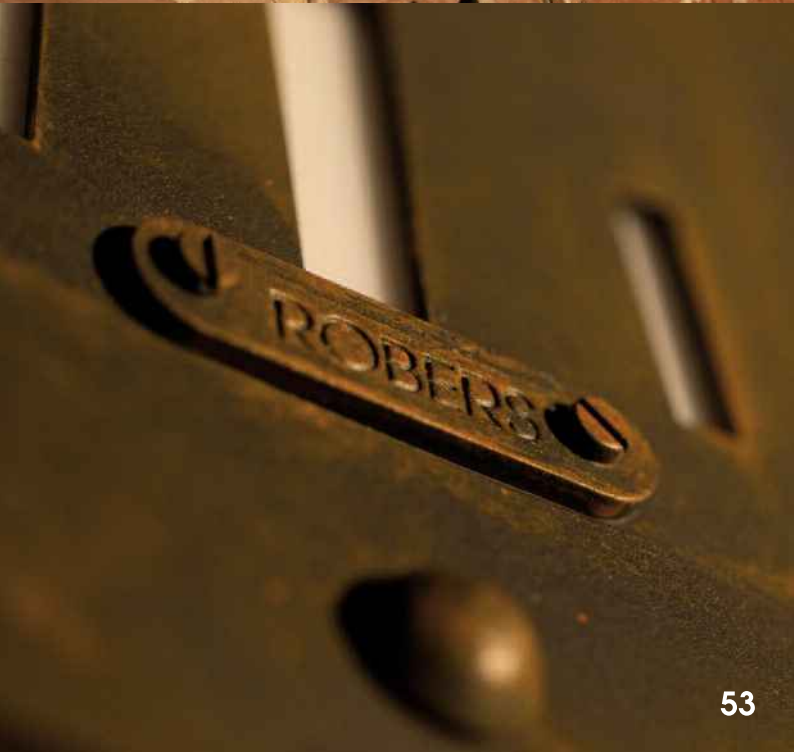



111.000.260
AQUARIUM

| | |
|--|---|
| BREITE / WIDTH: | 1000 MM / 39.5" |
| HÖHE / HEIGHT: | 2600 MM / 102.5" |
| TIEFE / DEPTH: | 700 MM / 27.5" |
| BECKEN / POOL: | 2 |
| VOLUMEN / VOLUME: | 2 X 300 L / 2 X 52.8 GAL |
| LICHT / LIGHT: | LED-TAGESLICHTSIMULATOR / LED-DAY LIGHT SIMULATOR |
| LACKIERUNG / FINISH: | EISEN NATUR / IRON-NATURE |
| GEWICHT WIE ABGEBILDET INKL. WASSER / WEIGHT AS SHOWN IN CATALOGUE INCL. WATER: | CA. 1200 KG |

UNSERE AQUARIEN WERDEN AUF MASS GEFERTIGT. WIR RICHTEN UNS NACH IHREN WÜNSCHEN.

OUR AQUARIUM IS CUSTOM MADE. MEANS WE CAN BUILT THE SIZE UPON YOUR REQUEST.

NOUS FAISON NOTRE AQUARIUM SUR MEASURE.





OUTDOOR



AL 6826



AL 6826
POLLERLEUCHE / POST LAMP

FASSUNG / SOCKET:
WATTZAHL / WATTAGE:
BREITE / WIDTH:
HÖHE / HEIGHT:
LACKIERUNG / FINISH:
GEWICHT / WEIGHT:

1 X E 27 / 1 X E 26
6 W LED
710 MM / 28"
1215 MM / 48"
TERRA
32 KG





WL 3636

WL 3636
WANDLEUCHE / WALL LAMP

FASSUNG / SOCKET: 1 X E 27 / 1 X E 26
 BREITE / WIDTH: 158 MM / 6,2"
 HÖHE / HEIGHT: 345 MM / 13,5"
 AUSLADUNG / DISTANCE TO WALL: 151 MM / 6"
 LACKIERUNG / FINISH: TERRA
 GEWICHT / WEIGHT: 6,8 KG

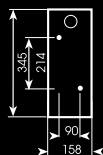

AL 6833
POLLERLEUCHE / POST LAMP

FASSUNG / SOCKET: 1 X E 27 / 1 X E 26
 BREITE / WIDTH: 160 MM / 6,5"
 HÖHE / HEIGHT: 1000 MM / 39"
 LACKIERUNG / FINISH: TERRA
 GEWICHT / WEIGHT: 18,4 KG

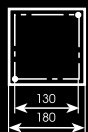

AL 6833



AL 6789

AL 6789

SOCKELLEUCHE / PEDESTAL LAMP
DECKENLEUCHE / CEILING LAMP

FASSUNG / SOCKET: 1 X E 27 / 1 X E 26
BREITE / WIDTH: 160 MM / 6"
HÖHE / HEIGHT: 350 MM / 14"
GLAS / GLASS: NR447 AUSSEN MATTIERT / OUTSIDE FROSTED
LACKIERUNG / FINISH: EISEN NATUR / IRON-NATURE
GEWICHT / WEIGHT: 6 KG



AL 6790 POLLERLEUCHE / POST LAMP

FASSUNG / SOCKET: 1 X E 27 / 1 X E 26
BREITE / WIDTH: 160 MM / 6"
HÖHE / HEIGHT: 1100 MM / 43"
GLAS / GLASS: NR447 AUSSEN MATTIERT / OUTSIDE FROSTED
LACKIERUNG / FINISH: EISEN NATUR / IRON-NATURE
GEWICHT / WEIGHT: 13 KG



AL 6790



AL 6789





WL 3630

WL 3630
WANDLEUCHTE / WALL LAMP

FASSUNG / SOCKET: 1 X E 27 / 1 X E 26
 BREITE / WIDTH: 160 MM / 6"
 HÖHE / HEIGHT: 500 MM / 20"
 AUSLADUNG / DISTANCE TO WALL: 180 MM / 7"
 GLAS / GLASS: NR285 OPALWEISS / OPAL WHITE
 LACKIERUNG / FINISH: EISEN NATUR / IRON-NATURE
 GEWICHT / WEIGHT: 9,6 KG

AL 6824
POLLERLEUCHTE / POST LAMP

FASSUNG / SOCKET: 1 X E 27 / 1 X E 26
 LÄNGE / LENGTH: 240 MM / 9,5"
 BREITE / WIDTH: 180 MM / 7"
 HÖHE / HEIGHT: 1100 MM / 43"
 GLAS / GLASS: NR285 OPALWEISS / OPAL WHITE
 LACKIERUNG / FINISH: EISEN NATUR / IRON-NATURE
 GEWICHT / WEIGHT: 17 KG

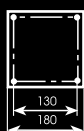

AL 6824



AL 6339



WL 3634

WL 3634
WANDLEUCHTE / WALL LAMP

| | |
|-------------------------------|---------------------------|
| FASSUNG / SOCKET: | INCL. 1 X LED-MODUL 4,3 W |
| BREITE / WIDTH: | 140 MM / 5,5" |
| HÖHE / HEIGHT: | 172 MM / 6,5" |
| AUSLADUNG / DISTANCE TO WALL: | 288 MM / 11,5" |
| LACKIERUNG / FINISH: | EISEN ROSTIG / IRON-RUSTY |
| GEWICHT / WEIGHT: | 6 KG |

AL 6829
POLLERLEUCHTE / POST LAMP

| | |
|----------------------|---------------------------|
| FASSUNG / SOCKET: | INCL. 1 X LED-MODUL 4,3W |
| BREITE / WIDTH: | 410 MM / 16" |
| HÖHE / HEIGHT: | 1115 MM / 44" |
| LACKIERUNG / FINISH: | EISEN ROSTIG / IRON-RUSTY |
| GEWICHT / WEIGHT: | 25,2 KG |



AL 6339
POLLERLEUCHTE / POST LAMP

| | |
|----------------------|---------------------------|
| FASSUNG / SOCKET: | 1 X E 27 / 1 X E 26 |
| BREITE / WIDTH: | 400 MM / 16" |
| HÖHE / HEIGHT: | 1060 MM / 42" |
| MACROLONZYLINDER: | Z 527 KLAR / CLEAR |
| LACKIERUNG / FINISH: | EISEN NATUR / IRON-NATURE |
| GEWICHT / WEIGHT: | 15 KG |



AL 6829

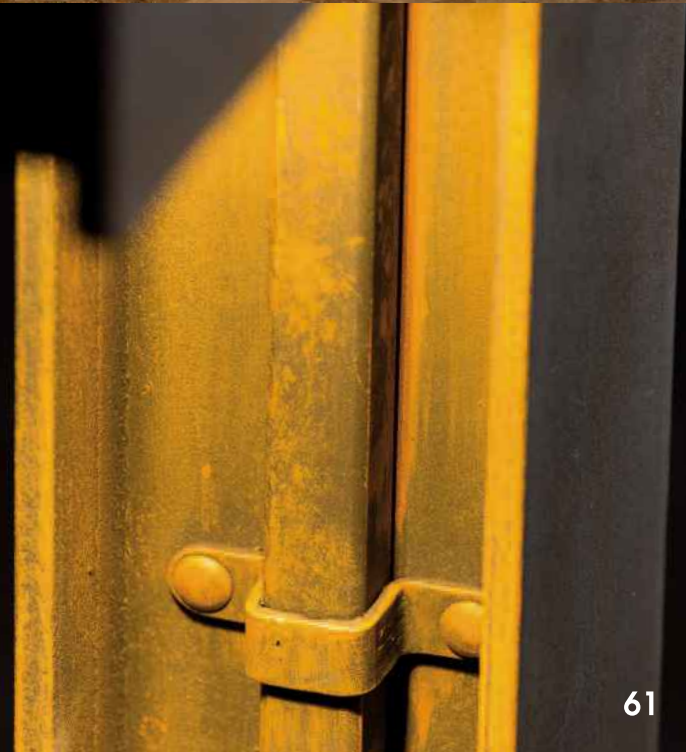

AL 6828 SOCKELLEUCHE / PEDESTAL LAMP

FASSUNG / SOCKET: 1 X E 27 / 1 X E 26
BREITE / WIDTH: 170 MM / 6,5"
HÖHE / HEIGHT: 365 MM / 14,5"
GLAS / GLASS: NR347 OPAL MATT / OPAL FROSTED
LACKIERUNG / FINISH: EISEN NATUR / IRON-NATURE
GEWICHT / WEIGHT: 15 KG

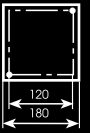

AL 6832 POLLERLEUCHE / POST LAMP

FASSUNG / SOCKET: 1 X E 27 / 1 X E 26
BREITE / WIDTH: 170 MM / 6,5"
HÖHE / HEIGHT: 1100 MM / 43"
GLAS / GLASS: NR347 OPAL MATT / OPAL FROSTED
LACKIERUNG / FINISH: EISEN NATUR / IRON-NATURE
GEWICHT / WEIGHT: 20 KG

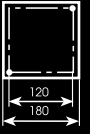

WL 3632-ST WANDLEUCHE / WALL LAMP

FASSUNG / SOCKET: 1 X E 27 / 1 X E 26 + GU 10
BREITE / WIDTH: 236 MM / 9,5"
HÖHE / HEIGHT: 400 MM / 16"
AUSLADUNG / DISTANCE TO WALL: 218 MM / 8,5"
GLAS / GLASS: NR347 OPAL MATT / OPAL FROSTED
LACKIERUNG / FINISH: EISEN NATUR / IRON-NATURE
GEWICHT / WEIGHT: 12,5 KG



AL 6828



WL 3632-ST



AL 6832



AL 6788

AL 6788
POLLERLEUCHTE / POST LAMP

FASSUNG / SOCKET:
 WATZAHL / WATTAGE:
 BREITE / WIDTH:
 HÖHE / HEIGHT:
 GLAS / GLASS:
 LACKIERUNG / FINISH:
 GEWICHT / WEIGHT:

1 X 2 G 11
 DULUX 24 W
 170 MM / 6.7"
 860 MM / 34"
 NR303 OPAL
 EISEN NATUR / IRON-NATURE
 19 KG

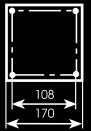

AL 6825
STECKDOSENPOLLER / BOLLARD WITH RECEPTACLES

BREITE / WIDTH:
 HÖHE / HEIGHT:
 LACKIERUNG / FINISH:
 GEWICHT / WEIGHT:

180 MM / 7"
 500 MM / 19.5"
 EISEN NATUR / IRON-NATURE
 8,2 KG

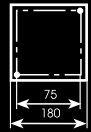

B 8709
HAUSNUMMER / HOUSE NUMBER

BREITE / WIDTH:
 HÖHE / HEIGHT:
 LACKIERUNG / FINISH:
 GEWICHT / WEIGHT:

300 MM / 11.8"
 170 MM / 6.7"
 EISEN NATUR / IRON-NATURE
 1,5 KG

BEI BESTELLUNG BITTE DIE GEWÜNSCHTE NUMMER ANGEBEN.
 PLEASE GIVE US YOUR REQUESTED NO. WITH ORDER.
 VEUILLEZ NOUS NOTIFIER LE NUMERO SOUHAITE LORS DE LA COMMANDE.



B 8709



AL 6825



**AL 6825
 OPEN**



WL 3586

WL 3586
WANDLEUCHTE / WALL LAMP

WATZAHL / WATTAGE: LED 4,3 W MIT OPTIK 20° / WITH 20° OPTICS
 BREITE / WIDTH: 120 MM / 5"
 HÖHE / HEIGHT: 780 MM / 30,5"
 AUSLADUNG / DISTANCE TO WALL: 120 MM / 4,5"
 LACKIERUNG / FINISH: EISEN NATUR / IRON-NATURE
 GEWICHT / WEIGHT: 11 KG

AL 6770
POLLERLEUCHTEN / POST LAMP

WATZAHL / WATTAGE: LED 4,3 W MIT OPTIK 20° / WITH 20° OPTICS
 BREITE / WIDTH: 120 MM / 5"
 HÖHE / HEIGHT: 1005 MM / 39,5"
 LACKIERUNG / FINISH: EISEN NATUR / IRON-NATURE
 GEWICHT / WEIGHT: 13KG

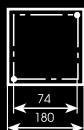

AL 6770



WL 3437



WL 3592

WL 3437 WANDLEUCHE / WALL LAMP

| | |
|-------------------------------|---------------------|
| FASSUNG / SOCKET: | 1 X E 27 / 1 X E 26 |
| BREITE / WIDTH: | 310 MM / 12" |
| HÖHE / HEIGHT: | 500 MM / 20" |
| AUSLADUNG / DISTANCE TO WALL: | 700 MM / 28" |
| LACKIERUNG / FINISH: | PATINA |
| GEWICHT / WEIGHT: | 5 KG |



WL 3592 WANDLEUCHE / WALL LAMP

| | |
|--------------------------------------|---------------------------|
| FASSUNG / SOCKET: | 1 X E 27 / 1 X E 26 |
| BREITE / WIDTH: | 910 MM / 36" |
| HÖHE / HEIGHT: | 890 MM / 35" |
| AUSLADUNG / DISTANCE TO WALL: | 1450 MM / 57" |
| DURCHMESSER SCHIRM / DIAMETER SHADE: | 500 MM / 20" |
| LACKIERUNG / FINISH: | EISEN NATUR / IRON NATURE |
| GEWICHT / WEIGHT: | 25 KG |

AL 6792 STÄNDERLEUCHE / POST LAMP

| | |
|----------------------|---------------------------|
| FASSUNG / SOCKET: | 1 X E 27 / 1 X E 26 |
| BREITE / WIDTH: | 1780 MM / 70" |
| HÖHE / HEIGHT: | 2220 MM / 87.4" |
| LACKIERUNG / FINISH: | EISEN NATUR / IRON-NATURE |
| GEWICHT / WEIGHT: | 39 KG |



WL 3592

AL 6792





WL 3638

WL 3638
WANDLEUCHE / WALL LAMP

FASSUNG / SOCKET: 1 X E 27 / 1 X E 26
 BREITE / WIDTH: 400 MM / 16"
 HÖHE / HEIGHT: 420 MM / 16.5"
 AUSLADUNG / DISTANCE TO WALL: 750 MM / 29.5"
 LACKIERUNG / FINISH: OLD BLACK
 GEWICHT / WEIGHT: 9 KG

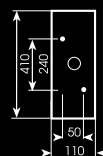

AL 6778-N
STÄNDERLEUCHE / POST LAMP

FASSUNG / SOCKET: 1 X E 27 / 1 X E 26
 BREITE / WIDTH: 800 MM / 31.5"
 HÖHE / HEIGHT: 2850 MM / 112"
 LACKIERUNG / FINISH: OLD BLACK
 GEWICHT / WEIGHT: 31 KG



AL 6835
2-FL. STÄNDERLEUCHE / 2-LIGHTER POST LAMP

FASSUNG / SOCKET: 2 X E 27 / 2 X E 26
 BREITE / WIDTH: 1600 MM / 63"
 HÖHE / HEIGHT: 2850 MM / 112"
 LACKIERUNG / FINISH: OLD BLACK
 GEWICHT / WEIGHT: 36 KG



AL 6835

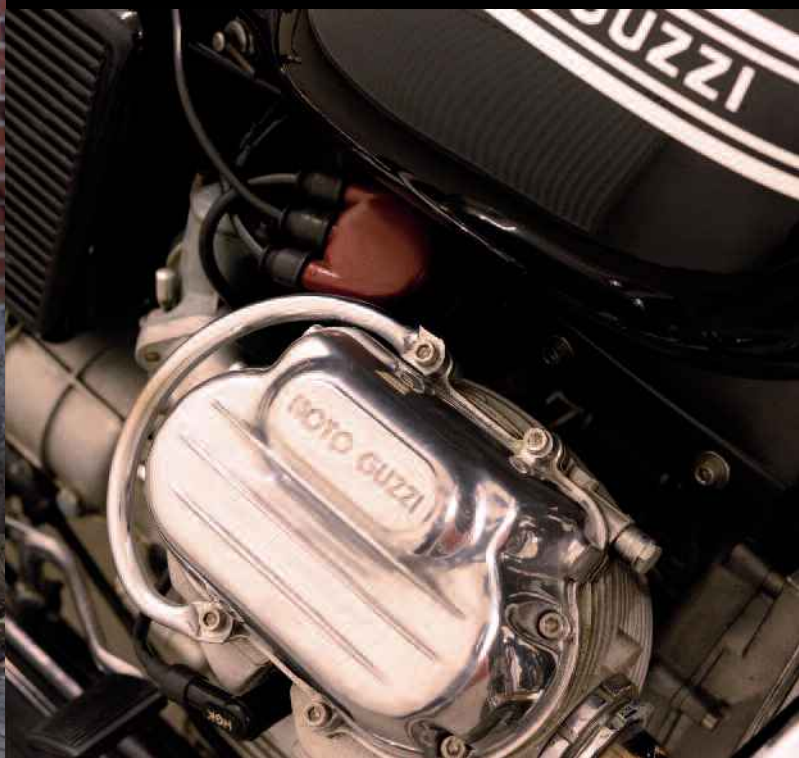



AL 6778-N



AL 6823

AL 6823

**POLLERLEUCHTE MIT STRAHLER /
POST LAMP WITH SPOT**

FASSUNG / SOCKET:

1 X E 27 / 1 X E 26

SPOT:

GU 10 LED

BREITE / WIDTH:

200 MM / 8"

HÖHE / HEIGHT:

420 MM / 16.5"

GLAS / GLASS:

NR124 OPALWEISS / OPAL WHITE

LACKIERUNG / FINISH:

EISEN NATUR / IRON-NATURE

GEWICHT / WEIGHT:

5,2 KG



AL 6774

**LED STRAHLER 2-FLAMMIG /
2-LIGHTER LED SPOT**

SPOT:

ALUMINIUMGUSS / CAST ALUMINIUM

T-TRÄGER / I-BEAM:

STAHL, FEUERVERZINKT /

STEEL HOT DIP GALVANIZED

SPOT:

2 X GU 10 LED

BREITE / WIDTH:

510 MM / 20"

HÖHE / HEIGHT:

1100 MM / 43"

LACKIERUNG / FINISH:

EISEN NATUR / IRON-NATURE

GEWICHT / WEIGHT:

32 KG

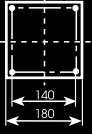

AL 6774



AL 6772

AL 6772

LED-STRAHLER / LED SPOT

| | |
|----------------------|---|
| SPOT: | ALUMINIUMGUSS / CAST ALUMINIUM |
| SOCKEL / POST: | STAHL, FEUERVERZINKT / STEEL HOT DIP GALVANIZED |
| SPOT: | GU 10 LED |
| BREITE / WIDTH: | 138 MM / 5.5 INCH |
| LÄNGE / LENGTH: | 160 MM / 6 INCH |
| HÖHE / HEIGHT: | 260 MM / 10 INCH |
| LACKIERUNG / FINISH: | EISEN NATUR / IRON-NATURE |
| GEWICHT / WEIGHT: | 3 KG |



AL 6772



WL 3635

WL 3635 WANDLEUCHE / WALL LAMP

FASSUNG / SOCKET: 1 X E 27 / 1 X E 26
BREITE / WIDTH: 400 MM / 16"
HÖHE / HEIGHT: 532 MM / 21"
AUSLADUNG / DISTANCE TO WALL: 845 MM / 33"
GLAS / GLASS: NR444 OPAL WEISS / OPAL WHITE
LACKIERUNG / FINISH: OLD COPPER
GEWICHT / WEIGHT: 13 KG

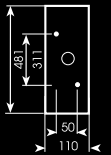

AL 6831 STÄNDERLEUCHE / POST LAMP

FASSUNG / SOCKET: 1 X E 27 / 1 X E 26
BREITE / WIDTH: 844 MM / 33"
HÖHE / HEIGHT: 3020 MM / 119"
GLAS / GLASS: NR444 OPAL WEISS / OPAL WHITE
LACKIERUNG / FINISH: OLD COPPER
GEWICHT / WEIGHT: 35 KG

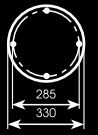

HL 2625 HÄNGELEUCHE / SUSPENSION LAMP

FASSUNG / SOCKET: 1 X E 27 / 1 X E 26
BREITE / WIDTH: 400 MM / 16"
HÖHE / HEIGHT: 364 MM / 14,5"
Ø BALDACHIN / Ø CANOPY: 160 MM / 6,5"
GLAS / GLASS: NR444 OPAL WEISS / OPAL WHITE
LACKIERUNG / FINISH: OLD COPPER
GEWICHT / WEIGHT: 8,5 KG



HL 2625





AL 6831



WL 3637



WL 3637 WANDLEUCHTE / WALL LAMP

WATTZAHL / WATTAGE: LED-MODUL 35 W, 3000 K,
2700 LM BEI 700 MA
BREITE / WIDTH: 270 MM / 10,5"
AUSLADUNG / DISTANCE TO WALL: 800 MM / 31,5"
HÖHE / HEIGHT: 386 MM / 15"
LACKIERUNG / FINISH: EISEN NATUR / IRON-NATURE
GEWICHT / WEIGHT: 24 KG

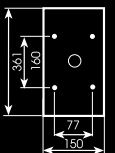

AL 6771-N STÄNDERLEUCHTE / POST LAMP

WATTZAHL / WATTAGE: LED-MODUL 35 W, 3000 K, 2700 LM BEI 700 MA
BREITE / WIDTH: 270 MM / 10,5"
AUSLADUNG / DISTANCE TO WALL: 2045 MM / 80,5"
HÖHE / HEIGHT: 4850 MM / 190"
LACKIERUNG / FINISH: EISEN NATUR / IRON-NATURE
GEWICHT / WEIGHT: 62 KG

MAST MIT INTEGRIERTEM ERDSTÜCK - FALLS EINE BODENPLATTE GEWÜNSCHT WIRD, BITTE ANGEBEN.

POLE WITH INTEGRATED EARTHPIECE, IF BASEPLATE NEEDED PLEASE LET US KNOW.

MAT AVEC FONDATION INTEGREE, LIVRE AVE PLATINE DE FIXATION SUR DEMANDE.



AL 6771-N



PB 1148

PB 1148
BANK / BENCH

TIEFE / DEPTH: 520 MM / 20.5"
 LÄNGE / LENGTH: 2057 MM / 81"
 HÖHE / HEIGHT: 500 MM / 20"
 LACKIERUNG / FINISH: EISEN NATUR / IRON-NATURE
 GEWICHT / WEIGHT: 47 KG

B 8707
PFLANZKÜBEL / BUCKET FOR PLANTS

TIEFE / DEPTH: 600 MM / 24"
 LÄNGE / LENGTH: 690 MM / 27"
 HÖHE / HEIGHT: 634 MM / 25"
 LACKIERUNG / FINISH: TERRA
 GEWICHT / WEIGHT: 47 KG

AL 6834
STÄNDERLEUCHE / POST LAMP

FASSUNG / SOCKET: 2 X E 27 / 2 X E 26
 BREITE / WIDTH: 890 MM / 35"
 HÖHE / HEIGHT: 2500 MM / 98"
 TIEFE / DEPTH: 440 MM / 17.3"
 LACKIERUNG / FINISH: OLD COPPER + EISEN ROSTIG + MESSING ANTIK /
 OLD COPPER + IRON-RUSTY + BRASS ANTIQUE
 GLAS / GLASS: NR141 + NR 285 KLAR / CLEAR
 GEWICHT / WEIGHT: 118 KG



B 8707





AL 6834

440

300

723
590

**B 8675 mit
B 8675-R**





B 8680

B 8675
FEUERSCHALE / FIREPLACE

DURCHMESSER / DIAMETER:
HÖHE / HEIGHT:
GEWICHT / WEIGHT:

1050 MM / 41"
400 MM / 15,5"
52 KG

B 8680
FEUERSCHALE / FIREPLACE

DURCHMESSER / DIAMETER:
HÖHE / HEIGHT:
GEWICHT / WEIGHT:

800 MM / 31,5"
300 MM / 12"
34 KG

B 8675-R
GESTELL / RACK

WIRD AUFGESTECKT, FÜR BEIDE FEUERSTELLEN PASSEND
RACK TO BE PUT ON THE I-BEAM, MATCHING FOR BOTH FIREPLACES

HÖHE / HEIGHT:
GEWICHT / WEIGHT:

CA. 2150 MM / 85"
18 KG





SONDERLEUCHTEN FÜR DIE FIRMA „THUNDERBIKE“
IN HAMMINKELN.

CUSTOM MADE LIGHTING FIXTURES FOR
„THUNDERBIKE“ IN HAMMINKELN, GERMANY.

LAMPES FAITS SUR MESURE POUR „THUNDERBIKE“
ALEMAGNE

WWW.THUNDERBIKE.DE

WL 3593

WANDLEUCHE / WALL LAMP

| | |
|-------------------------------|---------------------|
| FASSUNG / SOCKET: | 1 X E 27 / 1 X E 26 |
| BREITE / WIDTH: | 160 MM / 6" |
| HÖHE / HEIGHT: | 355 MM / 14" |
| AUSLADUNG / DISTANCE TO WALL: | 375 MM / 15" |
| LACKIERUNG / FINISH: | OLD BLACK |



WL 3591

WANDLEUCHE / WALL LAMP

| | |
|-------------------------------|---------------------|
| FASSUNG / SOCKET: | 1 X E 27 / 1 X E 26 |
| BREITE / WIDTH: | 280 MM / 11" |
| HÖHE / HEIGHT: | 490 MM / 19,3" |
| AUSLADUNG / DISTANCE TO WALL: | 735 MM / 29" |
| LACKIERUNG / FINISH: | OLD BLACK |





WL 3591



HL 2568



WL 3593

OBERFLÄCHEN COLOURS



EISEN NATUR / IRON NATURE



PATINA



EISEN ROSTIG / IRON-RUSTY



TERRA



OLD-COPPER



MESSING ANTIK / BRASS ANTIQUE



OLD-BRONZE



ANTI-K-GRÜN / ANTIQUE-GREEN



SCHWARZ-SILBER / BLACK-SILVER



OLD BLACK

ALLE LEUCHTEN WERDEN VON HAND LACKIERT, LEICHTE FARBABWEICHUNGEN SIND DAHER MÖGLICH. SELBST-VERSTÄNDLICH KÖNNEN DIE LEUCHTEN AUCH IN JEDER RAL-FARBE LACKIERT WERDEN.

THE FINAL FINISH IS MADE BY HAND, THEREFORE SLIGHT COLOUR DIFFERENCES ARE POSSIBLE. OF COURSE ALSO EVERY RAL COLOUR IS POSSIBLE.

TOUTES LES PATINES DE FINITION SONT PEINTES A LA MAIN, C'EST POURQUOI DE LEGERES NUANCES DE TEINTE SONT POSSIBLES. TOUTES LES COULEURS RAL SONT EGALEMENT REALISABLES.

**HANDMADE
LIGHTING
FROM
GERMANY**

ROBERS-LEUCHTEN
GmbH & Co. KG
Weseker Weg 36
46354 Südlohn - Germany
Tel.: ++49 (0) 28 62 - 99 77 - 0
Fax: ++49 (0) 28 62 - 99 77 77
Net: www.Robers.com
Mail: office@Robers.com