



<sup>®</sup>  
ROBERS

INDOOR  
2017 - 2020

casa  
lumi  
[www.casalumi.de](http://www.casalumi.de)

Sie erhalten sämtliche  
Robers-Produkte  
bei Casa Lumi, dem  
Fachhändler für exklusive  
Manufaktur-Leuchten.  
Wir beraten Sie gerne!



# ROBERS®



2





Seit 1964 werden in unserem Familienunternehmen in Südlohn Leuchten auf höchstem Niveau und in bester Qualität hergestellt.

Die Marke ROBERS steht für Tradition, Nachhaltigkeit und zeitlose Gestaltung. Entwicklung und Fertigung befinden sich unter einem Dach in unserem Werk in Südlohn. Dadurch erreichen wir eine sehr große Flexibilität. Die Leuchten werden von erfahrenen Schmieden in sorgfältiger Handarbeit hergestellt, somit wird jedes Stück zu einem Unikat.

Die verschiedenen Standardoberflächen haben wir auf Seite 81 abgebildet. Es werden nur hochwertige Materialien wie seewasserbeständiges Aluminium, Grauguß, Stahl – feuerverzinkt, Edelstahl und Kupfer verwendet.

Unsere Leuchten werden lichttechnisch ständig weiterentwickelt und können selbstverständlich mit LEDs und anderen innovativen Leuchtmitteln bestückt werden. Dadurch sind sie für die Zukunft gerüstet.

Die Leuchten sind anschlussfertig verdrahtet und nur mit hochwertigsten elektrischen Komponenten, welche das VDE Zeichen tragen, bestückt.

Aufgrund unserer Fertigungsmöglichkeiten sind wir in der Lage auf persönliche Kundenwünsche einzugehen. Dabei können wir nach Ihren Vorstellungen arbeiten oder Entwürfe für Sie ausarbeiten.

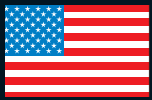

Since 1964 we have been producing high quality lighting fixtures in our family owned company in Südlohn/Germany.

The brand ROBERS symbolizes tradition, sustainability and timeless design. Development and production are under one roof at our plant in Südlohn. Thus, we achieve a high degree of flexibility.

Our lighting fixtures are carefully crafted by experienced blacksmiths. In this way each item becomes a unique touch. For different finishes see page 81. Only high-quality materials are used such as seawaterresistant aluminium, cast iron, hot-galvanized steel and copper.

Our lighting fixtures are constantly evolving regarding lighting technology and can of course be equipped with LEDs and other innovative light sources or can be prepared according to the dark sky regulations. Every lighting fixture and its electrical components are equipped to the required regulations as UL or SASO for example. Thus they are well prepared for the future.

The lighting fixtures are ready for installation at site and are equipped with high class electrical components.

Due to our manufacturing capabilities we can respond to special customer requests. Hereby we can realize your own ideas or we can give you our proposals.

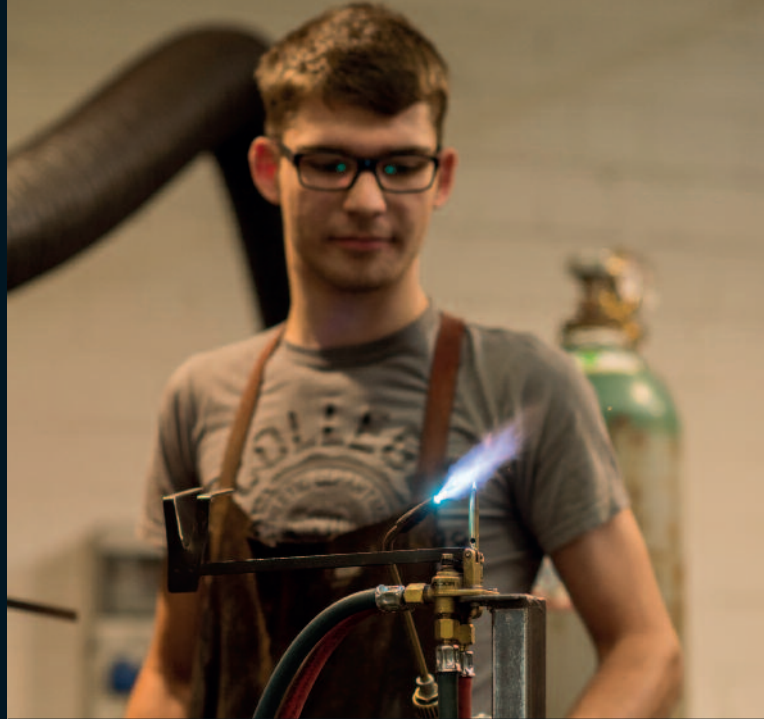



Начиная с 1964 года на нашем семейном предприятии в городе Зюдлон в Германии мы производим светильники высочайшего качества.

Марка ROBERS – это традиции, основательность и классический дизайн.

Новые идеи светильников рождаются в нашем доме и здесь же воплощаются в жизнь высококлассными мастерами ручнойковки. Это позволяет очень гибко реагировать на пожелания клиентов. Каждая работа мастеров уникальна.

В производстве используются только высококачественные материалы, такие как устойчивый к воздействию морской воды алюминий, чугун, оцинкованная сталь и медь.

Образцы покрытий, используемых при производстве изделий, представлены на странице 81.

Мы идем в ногу с техническими инновациями и уже сегодня оснащаем светильники светодиодными (LED) и другими современными энергосберегающими источниками света.

Светильники поставляются укомплектованными только высококачественными электрическими компонентами и готовыми к установке.

Наши производственные возможности позволяют осуществить самые изысканные пожелания клиента. Мы реализуем ваши представления по разработанному нами эскизу.





Depuis 1964 notre entreprise familiale installée à Südlohn en Allemagne produit des luminaires de prestige d'une qualité remarquable.

La marque ROBERS est reconnue pour l'authenticité et la valeur ajoutée de leurs créations intemporelles. Le fait de développer et de fabriquer les produits dans l'usine de Südlohn apporte une très grande souplesse d'adaptation. Les lampes sont réalisées dans le respect des traditions artisanales afin que chaque pièce reste unique.

Le panel des différentes finitions est représenté à la page 81.

Nous n'utilisons que des matériaux de grande qualité comme de l'aluminium insensible à l'eau de mer, de la fonte, de l'acier galvanisé à chaud, de l'inox, du bronze.

En constante évolution, les luminaires Robers sont adaptés à recevoir des techniques d'éclairages innovantes et performantes répondant aux normes de qualité.

Les lampes sont dotées de câblages et de composants électriques de qualité. Elles sont livrées prêt à brancher.

Grâce à notre adaptabilité, nous sommes en mesure de satisfaire les souhaits de nos clients. Nous pouvons travailler selon vos critères ou développer pour vous des projets spécifiques





**HL 2630  
Detail**

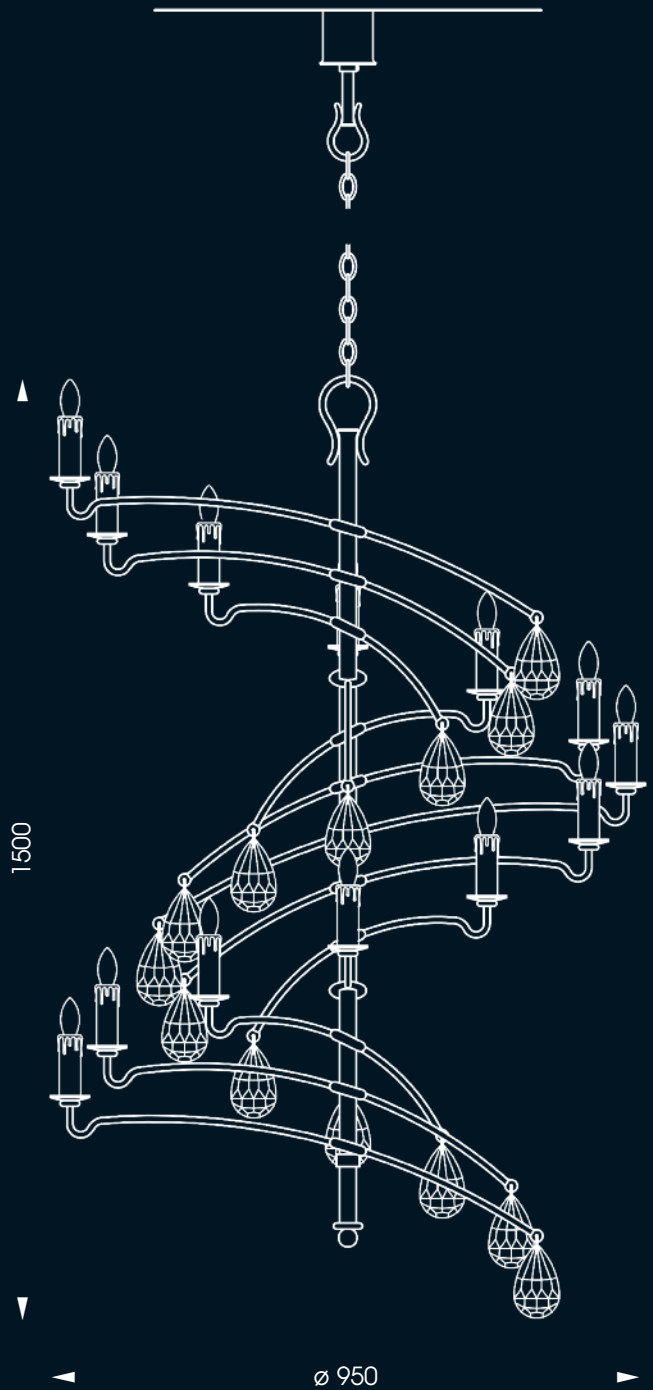

**HL 2630 12-fl. Hängeleuchte mit Bergkristall /  
12-lighter suspension lamp**

|                      |   |
|----------------------|---|
| Fassung / socket:    | 12 x E 14 / E 12                        |
| EEK / EEC:           | A++ - E                                 |
| Höhe / height:       | 1500 mm / 59 inch                       |
| Breite / width:      | 950 mm / 37 inch                        |
| Glas / glass:        | 12 x Nr. 351-OM /<br>12 x Kristall K 37 |
| Lackierung / finish: | old copper                              |
| Baldachin / canopy:  | B 38                                    |
| Kette / chain:       | K 1160 - 1,0 m                          |
| Gewicht / weight:    | 14,8 kg                                 |

Unsere Kristalle werden aus echten Bergkristallen einzeln von Hand in einer Edelsteinschleiferei in Idar Oberstein geschliffen. Einschlüsse und leichte Unregelmäßigkeiten unterstreichen den natürlichen Charakter dieser Schmuckstücke.

Our crystals each are cut by hand out of real rock crystal by a craftsman in Idar Oberstein/ Germany. The natural character of these pieces is shown in slight irregularities and surroundings.

Chacun de nos cristaux est soigneusement découpé de manière artisanale dans la pierre de roche à Idar Oberstein en Allemagne. Les légères aspérités observées sur les pièces témoignent de l'authenticité du cristal

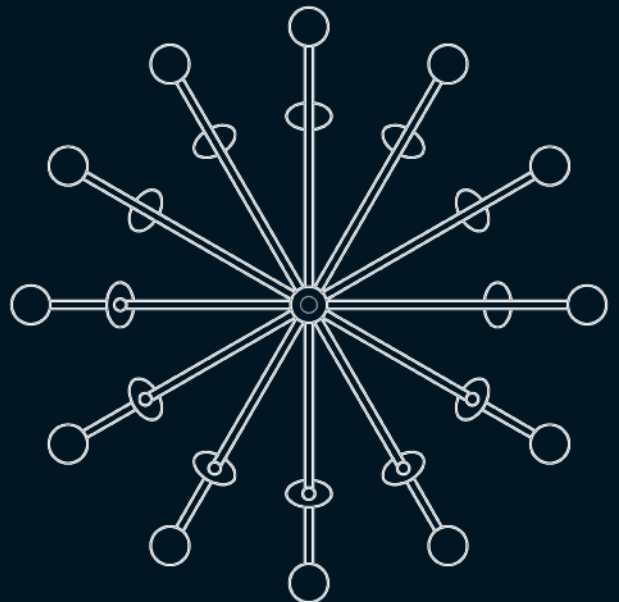



HL 2630



**SL 111**

**SL 111** 3-fl. Stehleuchte mit Bergkristall /  
3-lighter floor lamp

Fassung / socket - EEK / EEC: 3 x E 14 / E 12 - A++ - E  
 Höhe / height: 1325 mm / 52 inch  
 Breite / width: 450 mm / 17,7 inch  
 Glas / glass: 3 x Nr. 351-OM  
 3 x Kristall K 37  
 Lackierung / finish: old copper  
 Gewicht / weight: 10,1 kg

**TL 4103** Tischleuchte mit Bergkristall / table lamp

Fassung / socket - EEK / EEC: 1 x E 14 / E 12 - A++ - E  
 Höhe / height: 570 mm / 22,4 inch  
 Breite / width: 365 mm / 14,4 inch  
 Glas / glass: Nr. 351-OM  
 Kristall K 37  
 Lackierung / finish: old copper  
 Gewicht / weight: 4 kg

**WL 3645** Wandleuchte mit Bergkristall / wall lamp

Fassung / socket - EEK / EEC: 1 x E 14 / E 12 - A++ - E  
 Höhe / height: 397 mm / 15,6 inch  
 Breite / width: 360 mm / 14,2 inch  
 Ausladung / distance to wall: 90 mm / 3,5 inch  
 Glas / glass: Nr. 351-OM  
 Kristall K 37  
 Lackierung / finish: old copper  
 Gewicht / weight: 1,8 kg

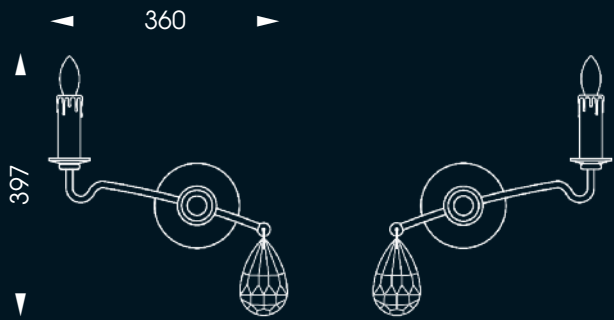

**WL 3645-L**

**WL 3645-R**



**TL 4103**



**WL 3645**



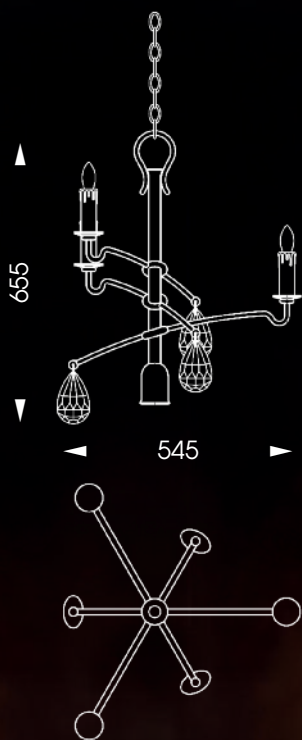

## HL 2637

### HL 2637 3-fl. Hängeleuchte mit Bergkristall / 3-lighter suspension lamp

|                        |                    |
|------------------------|--------------------|
| Fassung / socket:      | 3 x E 14 / E 12    |
| mit / with Downlights: | 1 x GU 10          |
| EEK / EEC:             | A++ - E            |
| Höhe / height:         | 655 mm / 25,8 inch |
| Breite / width:        | 545 mm / 21,5 inch |
| Glas / glass:          | 3 x Nr. 351-OM     |
|                        | 3 x Kristall K 37  |
| Lackierung / finish:   | old copper         |
| Baldachin / canopy:    | B 38               |
| Kette / chain:         | K 1160 - 1 m       |
| Gewicht / weight:      | 5,2 kg             |

Unsere Kristalle werden aus echten Bergkristallen einzeln von Hand in einer Edelsteinschleiferei in Idar Oberstein geschliffen. Einschlüsse und leichte Unregelmäßigkeiten unterstreichen den natürlichen Charakter dieser Schmuckstücke.

Our crystals each are cut by hand out of real rock crystal by a craftsman in Idar Oberstein/Germany. The natural character of these pieces is shown in slight irregularities and surroundings.

Chacun de nos cristaux est soigneusement découpé de manière artisanale dans la pierre de roche à Idar Oberstein en Allemagne. Les légères aspérités observées sur les pièces témoignent de l'authenticité du cristal.



### HL 2637 Detail



**B 8674**



**B 8674**  
**Detail**

**B 8674** Blumenampel / flower board

Höhe / height: 1675 mm / 66 inch  
Breite / width: 125 mm / 5 inch  
Ausladung / distance to wall: 90 mm / 3,5 inch  
Glas / glass: 3 x Nr. 449 klar / clear  
Lackierung / finish: eisen-natur / iron nature  
Gewicht / weight: 11 kg



**HL 2557**  
**Detail**



**HL 2557**

**HL 2557** 6-fl. Hängeleuchte /  
6-lighter suspension lamp

|                          |                                      |
|--------------------------|--------------------------------------|
| Fassung / socket:        | 6 x E 27 / E 26                      |
| mit / with Downlights:   | 3 x GU 10                            |
| EEK / EEC:               | A++ - E                              |
| Höhe / height:           | 270 mm / 10,5 inch                   |
| Durchmesser / diameter:  | 700 mm / 27,5 inch                   |
| Glas / glass:            | 6 x Nr. 285 Opal matt / opal frosted |
| Aufhängung / suspension: | Stahlseil / steel rope - 1,5 m       |
| Lackierung / finish:     | eisen-natur / iron nature            |
| Gewicht / weight:        | 19 kg                                |

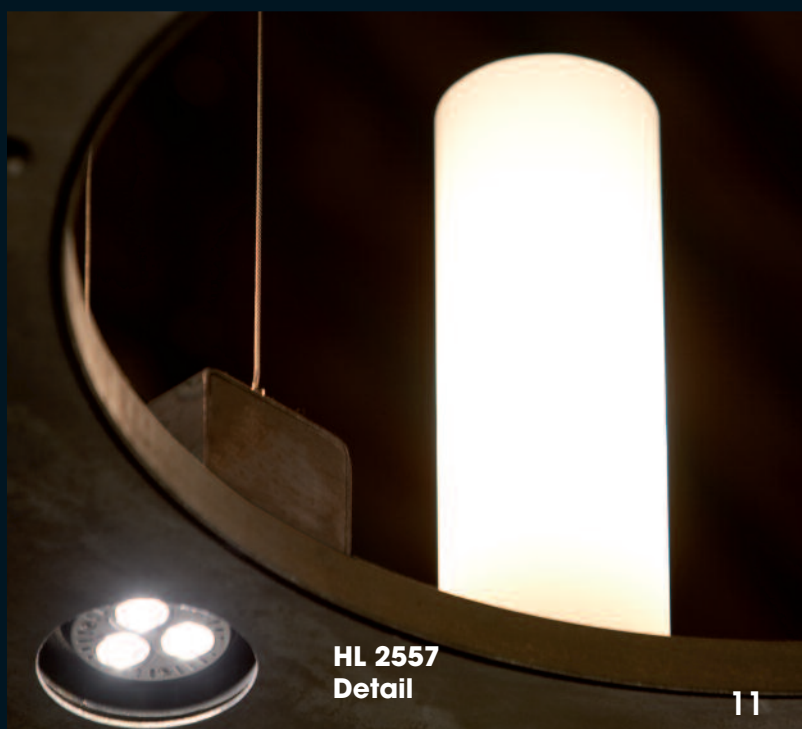
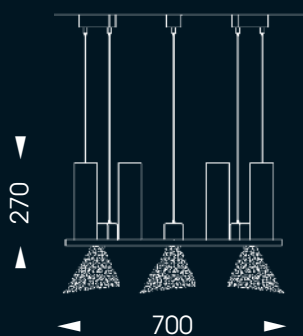

**HL 2557**  
Detail



**WL 3582**



**WL 3583**

### **WL 3583** Wandleuchte / wall lamp

|                               |                                      |
|-------------------------------|--------------------------------------|
| Fassung / socket:             | 3 x E 27 / E 26                      |
| EEK / EEC:                    | A++ - E                              |
| Höhe / height:                | 630 mm / 25 inch                     |
| Breite / width:               | 495 mm / 19,5 inch                   |
| Ausladung / distance to wall: | 130 mm / 5 inch                      |
| Glas / glass:                 | 3 x Nr. 285 Opal matt / opal frosted |
| Lackierung / finish:          | eisen-natur / iron nature            |
| Gewicht / weight:             | 9 kg                                 |

### **WL 3582** Wandleuchte / wall lamp

|                               |                                  |
|-------------------------------|----------------------------------|
| Fassung / socket:             | 1 x E 27 / E 26                  |
| EEK / EEC:                    | A++ - E                          |
| Höhe / height:                | 630 mm / 25 inch                 |
| Breite / width:               | 125 mm / 5 inch                  |
| Ausladung / distance to wall: | 130 mm / 5 inch                  |
| Glas / glass:                 | Nr. 285 Opal matt / opal frosted |
| Lackierung / finish:          | eisen-natur / iron nature        |
| Gewicht / weight:             | 3 kg                             |



**HL 2555**

**HL 2555** 5-fl. Hängeleuchte /  
5-lighter suspension lamp

|                          |                                      |
|--------------------------|--------------------------------------|
| Fassung / socket:        | 5 x E 27 / E 26                      |
| mit / with Downlights:   | 2 x GU 10                            |
| EEK / EEC:               | A++ - E                              |
| Höhe / height:           | 268 mm / 10,5 inch                   |
| Breite / width:          | 130 mm / 5 inch                      |
| Länge / length:          | 1275 mm / 50,2 inch                  |
| Glas / glass:            | 5 x Nr. 285 Opal matt / opal frosted |
| Aufhängung / suspension: | Stahlseil / steel rope - 1,5 m       |
| Lackierung / finish:     | eisen-natur / iron nature            |
| Gewicht / weight:        | 14 kg                                |

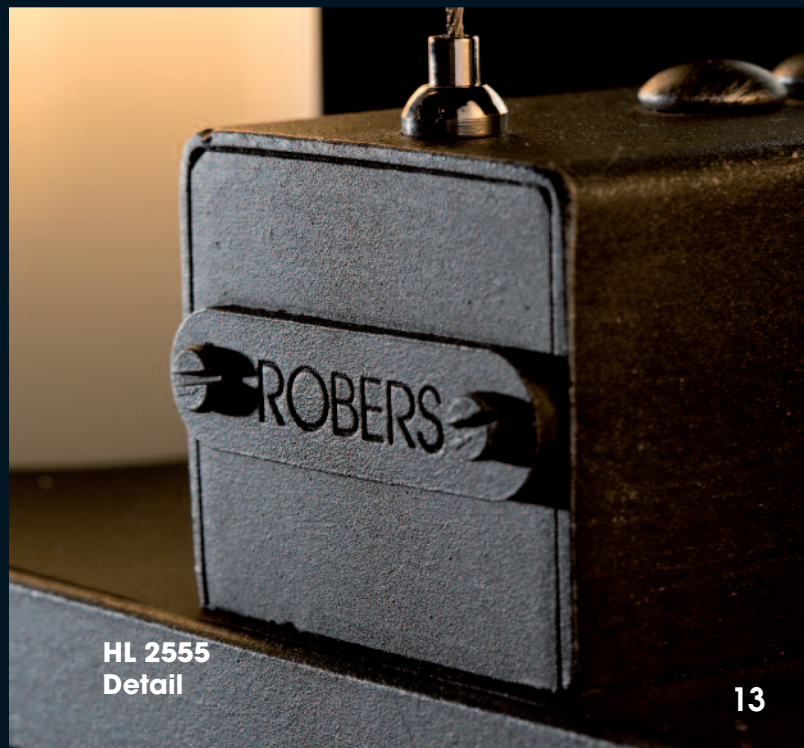
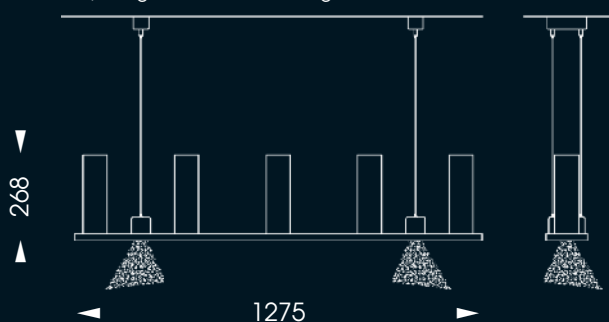

**HL 2555**  
Detail



**WL 3657**



**HL 2636**

**HL 2636** 9-fl. Hängeleuchte /  
9-lighter suspension lamp

Fassung / socket: 9 x E 27 / E 26  
mit / with Downlights: 3 x GU 10  
EEK / EEC: A++ - E  
Höhe / height: 270 mm / 10,6 inch  
Durchmesser / diameter: 1000 mm / 39 inch  
Glas / glass: 9 X Nr. 285 smoke  
Aufhängung / suspension: Stahlseil / steel rope - 1,5 m  
Lackierung / finish: eisen-natur / iron nature  
Gewicht / weight: 31 kg

**WL 3657** Wandleuchte / wall lamp

Fassung / socket - EEK / EEC: 3 x E 27 / E 26 - A++ - E  
Höhe / height: 1500 mm / 59 inch  
Breite / width: 125 mm / 5 inch  
Ausladung / distance to wall: 170 mm / 7 inch  
Glas / glass: 3 x Nr. 285 smoke  
Lackierung / finish: eisen-natur / iron nature  
Gewicht / weight: 11,6 kg



### WL 3582 Wandleuchte / wall lamp

Fassung / socket - EEK / EEC: 1 x E 27 / E 26 - A++ - E  
 Höhe / height: 630 mm / 25 inch  
 Breite / width: 125 mm / 5 inch  
 Ausladung / distance to wall: 130 mm / 5 inch  
 Glas / glass: Nr. 285 smoke  
 Lackierung / finish: eisen-natur / iron nature  
 Gewicht / weight: 3 kg

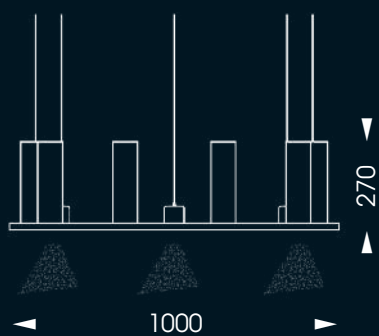

WL 3582



**HASELHOFF**  
HOTEL-RESTAURANT  
COESFELD, GERMANY





**DE 2638**

**DE 2638** Deckenleuchte / ceiling lamp

Fassung / socket: 1 x GU 10  
EEK / EEC: A++ - E  
Höhe / height: 262 mm / 10 inch  
Breite / width: 600 mm / 24 inch  
Lackierung / finish: eisen-natur, Goldfarbe /  
iron nature, goldpaint  
Gewicht / weight: 12 kg

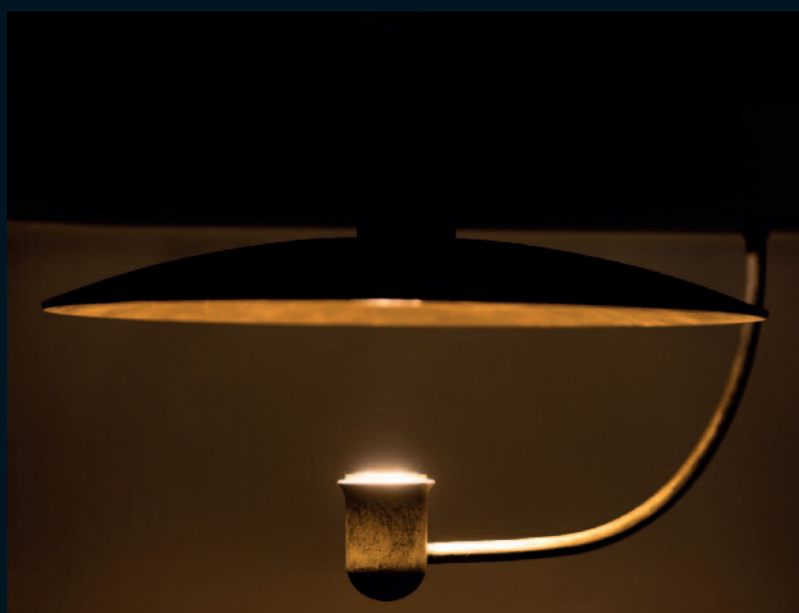

**DE 2638**  
Detail

**HL 2560**  
**Detail**



**HL 2560**  
21-fl. Hängeleuchte mit Kette /  
21-lighter suspension lamp with chain

|                        |   |
|------------------------|---|
| Fassung / socket:      | 21 x E 27 / E 26                                  |
| mit / with Downlights: | 3 x GU 10   |
| EEK / EEC:             | A++ - E   |
| Höhe / height:         | 1020 mm / 40,2 inch                               |
| Breite / width:        | 1000 mm / 39,4 inch                               |
| Glas / glass:          | 8 x Nr. 345-OM / 8 x Nr. 346-OM<br>5 x Nr. 347-OM |
| Lackierung / finish:   | eisen-natur / iron nature                         |
| Baldachin / canopy:    | B 38  |
| Kette / chain:         | K 1160 - 1 m                                      |
| Gewicht / weight:      | 65 kg   |

**HL 2560**





**WL 3576**

**WL 3576** Wandleuchte / wall lamp

Fassung / socket: 9 x E 27 / E 26  
 EEK / EEC: A++ - E  
 Höhe / height: 500 mm / 19,5 inch  
 Breite / width: 1250 mm / 50 inch  
 Ausladung / distance to wall: 185 mm / 7,5 inch  
 Glas / glass: 2 x Nr. 345-OM / 3 x Nr. 346-OM / 4 x Nr. 347-OM  
 Lackierung / finish: eisen-natur / iron nature  
 Gewicht / weight: 20 kg

**HL 2509** 8-fl. Hängeleuchte / 8-lighter suspension lamp

Fassung / socket: 8 x E 27 / E 26  
 mit / with Downlights: 2 x GU 10  
 EEK / EEC: A++ - E  
 Höhe / height: 270 mm / 10 inch  
 Breite / width: 130 mm / 5 inch  
 Länge / length: 1180 mm / 47 inch  
 Aufhängung / suspension: Stahlseil / steel rope - 1,5 m  
 Glas / glass: 3 x Nr. 345-OM / 3 x Nr. 346-OM / 2 x Nr. 347-OM  
 Lackierung / finish: eisen-natur / iron nature  
 Gewicht / weight: 18 kg



**HL 2509**



**HL 2509**  
Detail



**WL 3484**

**WL 3484** Wandleuchte / wall lamp

Fassung / socket - EEK / EEC: 1 x E 27 / E 26 - A++ - E  
 Höhe / height: 335 mm / 13 inch  
 Breite / width: 165 mm / 6 inch  
 Ausladung / distance to wall: 185 mm / 7 inch  
 Glas / glass: 1 x Nr. 347-OM  
 Lackierung / finish: old black  
 Gewicht / weight: 3,9 kg

**WL 3484-ST** Wandleuchte / wall lamp

Fassung / socket - EEK / EEC: 1 x E 27 / E 26 + 1 x GU 10 - A++ - E  
 Höhe / height: 335 mm / 13 inch  
 Breite / width: 165 mm / 6 inch  
 Ausladung / distance to wall: 185 mm / 7 inch  
 Glas / glass: 1 x Nr. 347-OM  
 Lackierung / finish: patina  
 Gewicht / weight: 4,1 kg

**WL 3603** Wandleuchte / wall lamp

Fassung / socket - EEK / EEC: 3 x E 27 / E 26 + 1 x GU 10 - A++ - E  
 Höhe / height: 335 mm / 13 inch  
 Breite / width: 387 mm / 15 inch  
 Ausladung / distance to wall: 185 mm / 7 inch  
 Glas / glass: 1 x Nr. 345-OM / 1 x Nr. 346-OM /  
 1 x Nr. 347-OM  
 Lackierung / finish: patina  
 Gewicht / weight: 11 kg



**WL 3484-ST**



**HL 2509**  
Detail



**WL 3603**



25.000.573-B

# LANDGUT AM HOCHWALD SONSBECK, GERMANY

## 25.000.573-B 50-fl. Hängeleuchte mit Kette / 50-lighter suspension lamp with chain

Fassung / socket - EEK / EEC: 50 x E 27 / E 26 - A++ - E  
mit / with Downlights: 10 x GU 10  
Höhe / height: 2200 mm / 87 inch  
Durchmesser / diameter: 1800 mm / 70 inch  
2500 mm / 99 inch  
20 x Nr. 345-OM / 20 x Nr. 346-OM  
10 x Nr. 347-OM  
Glas / glass:  
Lackierung / finish: patina  
Gewicht / weight: 170 kg

## HL 2430 8-fl. Hängeleuchte mit Kette / 8-lighter suspension lamp with chain

Fassung / socket - EEK / EEC: 8 x E 27 / E 26 - A++ - E  
mit / with Downlights: 2 x GU 10  
Höhe / height: 930 mm / 37 inch  
Breite / width: 150 mm / 6 inch  
Länge / length: 1180 mm / 47 inch  
Glas / glass: 3 x Nr. 345-OM / 3 x Nr. 346-OM  
2 x Nr. 347-OM  
Lackierung / finish: eisen-natur/ iron nature  
Kette / chain: K 1159 - 1 m  
Gewicht / weight: 20 kg



**HL 2430**  
Detail





### **WL 3625** Wandleuchte / wall lamp

Fassung / socket - EEK / EEC: 1 x E 27 / E 26 - A++ - E  
Höhe / height: 1300 mm / 51 inch  
Breite / width: 100 mm / 4 inch  
Ausladung / distance to wall: 220 mm / 8,7 inch  
Glas / glass: Nr. 346-OM  
Lackierung / finish: eisen-natur / iron nature  
Gewicht / weight: 6,4 kg

### **SL 105** Stehleuchte / floor lamp

Fassung / socket - EEK / EEC: 2 x E 27 / E 26 - A++ - E  
Höhe / height: 1840 mm / 72 inch  
Breite / width: 420 mm / 16 inch  
Glas / glass: 2 x Nr. 346-OM  
Lackierung / finish: eisen-natur / iron nature  
Gewicht / weight: 20 kg

### **TL 4100** Tischleuchte / table lamp

Fassung / socket - EEK / EEC: 1 x E 27 / E 26 - A++ - E  
Höhe / height: 250 mm / 10 inch  
Durchmesser / diameter: 160 mm / 6 inch  
Glas / glass: Nr. 346-OM  
Lackierung / finish: eisen-natur / iron nature  
Gewicht / weight: 2 kg



**SL 105**

**TL 4100**





WL 3625





**HL 2491**

**B 15**



**HL 2491**

Hängeleuchte mit Kette /  
suspension lamp with chain

Fassung / socket: 1 x E 27 / E 26  
mit / with Downlights: 1 x GU 10  
EEK / EEC: A++ - E  
Höhe / height: 530 mm / 21 inch  
Breite / width: 260 mm / 10 inch  
Glas / glass: Nr. 347-OM, klar / clear  
Lackierung / finish: patina  
Baldachin / canopy: B 15  
Kette / chain: K 1160 - 1 m  
Gewicht / weight: 13 kg

**WL 3655** Wandleuchte / wall lamp

Fassung / socket: 3 x E 27 / E 26  
EEK / EEC: A++ - E  
Höhe / height: 650 mm / 25,5 inch  
Breite / width: 400 mm / 16 inch  
Ausladung / distance to wall: 170 mm / 7 inch  
Glas / glass: 1 x Nr. 345-OM / 1 x Nr. 346-OM /  
1 x Nr. 347-OM  
Lackierung / finish: eisen-natur / iron nature  
Gewicht / weight: 11,7 kg

**WL 3654** Wandleuchte / wall lamp

Fassung / socket: 1 x E 27 / E 26  
EEK / EEC: A++ - E  
Höhe / height: 650 mm / 25,5 inch  
Breite / width: 125 mm / 5 inch  
Ausladung / distance to wall: 170 mm / 7 inch  
Glas / glass: Nr. 346-OM  
Lackierung / finish: eisen-natur / iron nature  
Gewicht / weight: 3,8 kg

**WL 3656** Wandleuchte / wall lamp

Fassung / socket: 3 x E 27 / E 26  
EEK / EEC: A++ - E  
Höhe / height: 1500 mm / 59 inch  
Breite / width: 125 mm / 5 inch  
Ausladung / distance to wall: 170 mm / 7 inch  
Glas / glass: 3 x Nr. 347-OM  
Lackierung / finish: eisen-natur / iron nature  
Gewicht / weight: 10,6 kg



**HL 2491**  
Detail



WL 3655



WL 3654



WL 3656



**WL 3651**



**WL 3651  
Detail**

**WL 3651** Wandleuchte / wall lamp

|                               |                           |
|-------------------------------|---------------------------|
| Fassung / socket:             | 1 x E 27 / E 26           |
| mit / with Downlights:        | 1 x GU 10                 |
| EEK / EEC:                    | A++ - E                   |
| Höhe / height:                | 298 mm / 11,7 inch        |
| Breite / width:               | 276mm / 10,9 inch         |
| Ausladung / distance to wall: | 187 mm / 7,4 inch         |
| Glas / glass:                 | 4 x Nr. 483, klar / clear |
| Lackierung / finish:          | eisen-rostig / iron rusty |
| Gewicht / weight:             | 3,8 kg                    |



## HL 2633 Detail

### HL 2633 Hängeleuchte / suspension lamp

|                        |                           |
|------------------------|---------------------------|
| Fassung / socket:      | 1 x E 27 / E 26           |
| mit / with Downlights: | 1 x GU 10                 |
| EEK / EEC:             | A++ - E                   |
| Höhe / height:         | 277 mm / 11,8 inch        |
| Breite / width:        | 276 mm / 11,9 inch        |
| Glas / glass:          | 6 x Nr. 483, klar / clear |
| Lackierung / finish:   | eisen-rostig / iron rusty |
| Gewicht / weight:      | 7 kg                      |

Die Gesamthöhe der Leuchte, inklusive Aufhängung, wird Ihrem Wunsch entsprechend gefertigt.

The over all height of this fixture will be made according to your requirements.

La hauteur totale du luminaire, système d'attache compris, sera confectionné selon vos souhaits.



## HL 2633 Detail



HL 2633

# LE BISTROT GOURMAND

REMERSCHEN,  
LUXEMBOURG



33.000.087-BI



33.000.087-AI



33.000.087-BI  
Detail



### 33.000.087-AI

#### Hängeleuchte / suspension lamp

Fassung / socket - EEK / EEC: 1 x E 27 / E 26 + GU 10 - A++ - E  
 Höhe / height: 900 mm / 35 inch  
 Durchmesser / diameter: 180 mm / 7 inch  
 Glas / glass: 1 x Nr. 333-OM  
 Lackierung / finish: eisen-natur / iron nature  
 Gewicht / weight: 3,2 kg

Die Gesamthöhe der Leuchte, inklusive Aufhängung, wird Ihrem Wunsch entsprechend gefertigt.

The over all height of this fixture will be made according to your requirements.

La hauteur totale du luminaire, système d'attache compris, sera confectionné selon vos souhaits.

### 33.000.087-BI

#### Wandleuchte / wall lamp

Fassung / socket - EEK / EEC: 3 x E 27 / E 26 - A++ - E  
 Höhe / height: 1300 mm / 51 inch  
 Breite / width: 160 mm / 6,5 inch  
 Ausladung / distance to wall: 180 mm / 7 inch  
 Glas / glass: 3 x Nr. 116-OM  
 Lackierung / finish: eisen-natur / iron nature



**33.000.087-AI**  
Detail

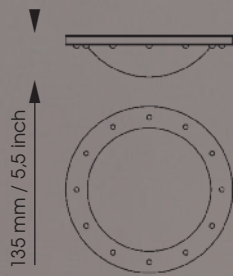

540 mm  
21 inch

**DE 2551**

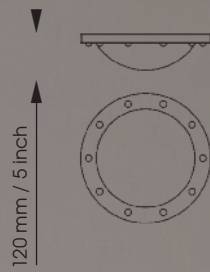

120 mm / 5 inch

420 mm  
16,5 inch

**DE 2550**

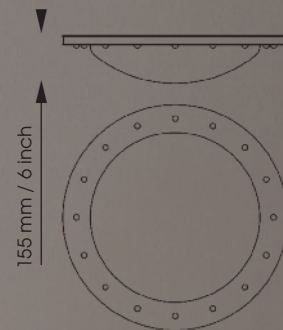

155 mm / 6 inch

730 mm  
29 inch

**DE 2552**



**DE 2550  
Detail**

### **DE 2550** Deckenleuchte / ceiling lamp

Fassung / socket - EEK / EEC: 2 x E 27 / E 26 - A++ - E  
 Höhe / height: 120 mm / 5 inch  
 Durchmesser / diameter: 420 mm / 16.5 inch  
 Glas / glass: Nr. 320 opalweiss / opalwhite  
 Lackierung / finish: eisen-natur / iron nature  
 Gewicht / weight: 8 kg

### **DE 2551** Deckenleuchte / ceiling lamp

Fassung / socket - EEK / EEC: 3 x E 27 / E 26 - A++ - E  
 Höhe / height: 135 mm / 5.5 inch  
 Durchmesser / diameter: 540 mm / 21 inch  
 Glas / glass: Nr. 321 opalweiss / opalwhite  
 Lackierung / finish: eisen-natur / iron nature  
 Gewicht / weight: 10 kg

### **DE 2552** Deckenleuchte / ceiling lamp

Fassung / socket - EEK / EEC: 3 x E 27 / E 26 - A++ - E  
 Höhe / height: 155 mm / 6 inch  
 Durchmesser / diameter: 730 mm / 29 inch  
 Glas / glass: Nr. 322 opalweiss / opalwhite  
 Lackierung / finish: eisen-natur / iron nature  
 Gewicht / weight: 14 kg



**SL 109  
Detail**



**SL 109 Stehleuchte / floor lamp**

|                      |                           |
|----------------------|---------------------------|
| Fassung / socket:    | 1 x E 27 / E 26           |
| EEK / EEC:           | A++ - E                   |
| Höhe / height:       | 1420 mm / 56 inch         |
| Breite / width:      | 360 mm / 14 inch          |
| Tiefe / depth:       | 270 mm / 10,5 inch        |
| Lackierung / finish: | eisen-natur / iron nature |
| Gewicht / weight:    | 15 kg                     |

**SL 109  
Detail**



SL 109



**DE 2627**

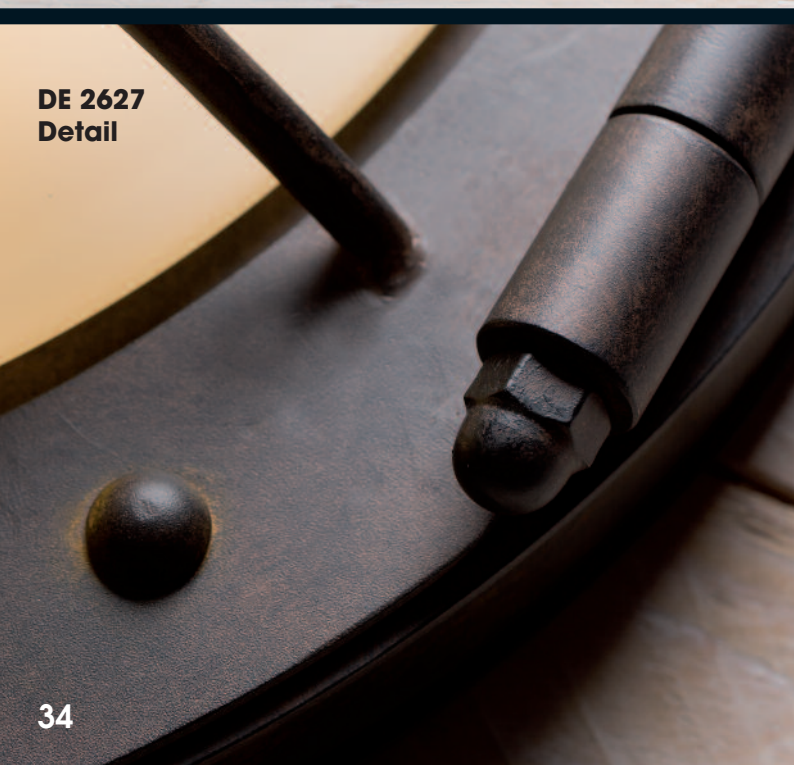

**DE 2627  
Detail**

**DE 2626** Deckenleuchte / ceiling lamp

Fassung / socket - EEK / EEC: 2 x E 27 / E 26 - A++ - E  
 Höhe / height: 120 mm / 5 inch  
 Durchmesser / diameter: 420 mm / 16.5 inch  
 Glas / glass: Nr. 320 opalweiss / opalwhite  
 Lackierung / finish: terra  
 Gewicht / weight: 10 kg

**DE 2627** Deckenleuchte / ceiling lamp

Fassung / socket - EEK / EEC: 3 x E 27 / E 26 - A++ - E  
 Höhe / height: 135 mm / 5,5 inch  
 Durchmesser / diameter: 540 mm / 21 inch  
 Glas / glass: Nr. 321 opalweiss / opalwhite  
 Lackierung / finish: terra  
 Gewicht / weight: 14,2 kg

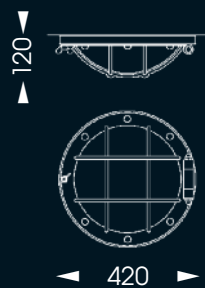

**DE 2626**

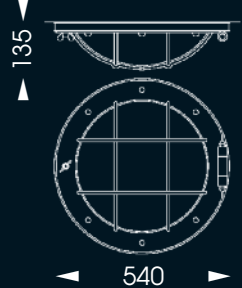

**DE 2627**



**WL 3673**

**WL 3673** Wandleuchte / wall lamp

Fassung / socket - EEK / EEC: 1 x E 27 / E 26 - A++ - E  
Höhe / height: 300 mm / 12 inch  
Breite / width: 120 mm / 5 inch  
Ausladung / distance to wall: 170 mm / 7 inch  
Lackierung / finish: terra  
Gewicht / weight: 2,4 kg

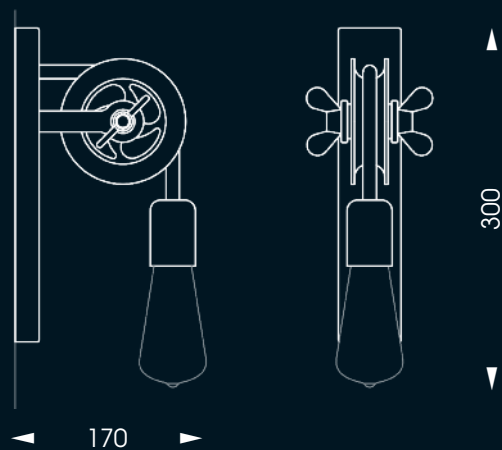

**WL 3673**  
Detail



WL 3663



**SL 113**  
**Detail**

### **SL 113** Stehleuchte / floor lamp

|                        |                                |
|------------------------|--------------------------------|
| Fassung / socket:      | 5 x GU 10                      |
| EEK / EEC:             | A+                             |
| Höhe / height:         | ca. 1110 mm / approx 43,7 inch |
| Durchmesser/ diameter: | 250 mm / 9,8 inch              |
| Glas / glass:          | 5 x Nr. 475                    |
| Lackierung / finish:   | eisen-natur / iron nature      |
| Gewicht / weight:      | 19,7 kg                        |

### **WL 3663** Wandleuchte / wall lamp

|                               |                               |
|-------------------------------|-------------------------------|
| Fassung / socket:             | 3 X GU 10                     |
| mit / with Downlight:         | 1 x GU 10                     |
| EEK / EEC:                    | A+                            |
| Höhe / height:                | ca. 880 mm / approx 34,6 inch |
| Breite / width:               | 250 mm / 9,8 inch             |
| Ausladung / distance to wall: | 170 mm / 6,7 inch             |
| Glas / glass:                 | 3 x Nr. 475                   |
| Lackierung / finish:          | eisen-natur / iron nature     |
| Gewicht / weight:             | 10,2 kg                       |

Diese Leuchten werden inkl. Leuchtmittel geliefert / delivery lamp included  
6 Watt, 24°, 3000 K



**SL 113**  
**Detail**



**SL 113**

# SCHLOSSCAFÉ NUSSKNACKER

ÖHRINGEN, GERMANY

25.000.624-C







ST 2619

ST 2615



**ST 2619 Strahler / spot**

|                               |                           |
|-------------------------------|---------------------------|
| Fassung / socket:             | GU 10                     |
| EEK / EEC:                    | A++ - E                   |
| Höhe / height:                | 130 mm / 5 inch           |
| Breite / width:               | 130 mm / 5 inch           |
| Ausladung / distance to wall: | 128 mm / 5 inch           |
| Lackierung / finish:          | eisen-natur / iron nature |
| Gewicht / weight:             | 1,2 kg                    |

**ST 2615 Strahler / spot**

|                      |                           |
|----------------------|---------------------------|
| Fassung / socket:    | GU 10                     |
| EEK / EEC:           | A++ - E                   |
| Höhe / height:       | 90 mm / 3,5 inch          |
| Breite / width:      | 150 mm / 6 inch           |
| Lackierung / finish: | eisen-natur / iron nature |
| Gewicht / weight:    | 1,4 kg                    |

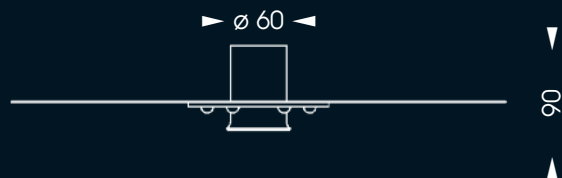





**ST 2628**

**ST 2628 Strahlerleiste / spot rail**

Fassung / socket: 3 x E 27 / E 26  
EEK / EEC: A++ - E  
Höhe / height: 90 mm / 3.5 inch  
Breite / width: 150 mm / 6 inch  
Länge / length: 730 mm / 29 inch  
Lackierung / finish: eisen-natur / iron nature  
Gewicht / weight: 8,4 kg

**ST 2614 Strahler / spot**

Fassung / socket: 1 x E 27 / E 26  
EEK / EEC: A++ - E  
Höhe / height: 200 mm / 8 inch  
Breite / width: 120 mm / 5 inch  
Ausladung / distance to wall: 180 mm / 7 inch  
Lackierung / finish: eisen-natur / iron nature  
Gewicht / weight: 2,2 kg



**ST 2614  
Detail**

**ST 2614**



25.000.777-D



THE ASH  
AMERICAN STEAK HOUSE  
TROISDORF, GERMANY

25.000.777-B





Auf dieser Seite sehen Sie einen nach Kundenwunsch von uns ausgestatteten Weinkeller inkl. LED-Beleuchtung.

On this page you see a wine cellar with custom made equipment from ROBERS incl. LED backlighting.

À cette page, découvrez une cave à vin réalisée sur mesure avec du mobilier ROBERS incluant un système d'éclairage à LED.

### **HL 2569-400** Hängeleuchte / suspension lamp

|                         |   |
|-------------------------|---|
| Fassung / socket:       | 1 x E 27 / E 26   |
| EEK / EEC:              | A++ - E   |
| Höhe / height:          | 276 mm / 11 inch  |
| Durchmesser / diameter: | 400 mm / 15,7 inch                                      |
| Lackierung / finish:    | eisen-natur, innen weiss /<br>iron nature, inside white |
| Gewicht / weight:       | 4 kg  |

Die Gesamthöhe der Leuchte, inklusive Aufhängung, wird Ihrem Wunsch entsprechend gefertigt.

The over all height of this fixture will be made according to your requirements.

La hauteur totale du luminaire, système d'attache compris, sera confectionné selon vos souhaits.



◀ 300 ▶

▲ 209 ▼



HL 2569-300

◀ 400 ▶

▲ 276 ▼



HL 2569-400

◀ 500 ▶

▲ 343 ▼

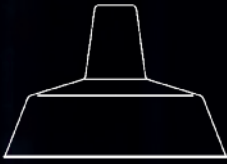

HL 2569-500



**HL 2569-400**



**HL 2569-400  
Detail**



**HL 2569-400  
Detail**



**HL 2642**



**HL 2642  
Detail**

**HL 2641** Hängeleuchte / suspension lamp

|                      |   |
|----------------------|---|
| Fassung / socket:    | 1 x E 27 / E 26                               |
| EEK / EEC:           | A++ - E                                       |
| Höhe / height:       | 356 mm / 14 inch (Leuchtenkörper / lamp body) |
| Breite / width:      | 200 mm / 8 inch                               |
| Glas / glass:        | Nr. 482 opalweiss / opalwhite                 |
| Lackierung / finish: | old copper                                    |
| Gewicht / weight:    | 4,5 kg  |

**HL 2642** 2-fl. Hängeleuchte / 2-lighter suspension lamp

|                      |                                   |
|----------------------|-----------------------------------|
| Fassung / socket:    | 2 x E 27 / E 26                   |
| EEK / EEC:           | A++ - E                           |
| Höhe / height:       | 500 mm / 19,7 inch                |
| Breite / width:      | 1000 mm / 39,4 inch               |
| Glas / glass:        | 2 x Nr. 482 opalweiss / opalwhite |
| Lackierung / finish: | old copper                        |
| Gewicht / weight:    | 9 kg                              |

Die Gesamthöhe der Leuchte, inklusive Aufhängung, wird Ihrem Wunsch entsprechend gefertigt.

The over all height of this fixture will be made according to your requirements.

La hauteur totale du luminaire, système d'attache compris, sera confectionné selon vos souhaits.



HL 2641



H 16935



H 16934



# BEACH HOUSE

REGENSBURG, GERMANY



25.000.781-H1

## H 16934 Barhocker / bar stool

Höhe / height: 460 - 630 mm / 19 - 25 inch  
Breite / width: 440 mm / 17,3 inch  
Tiefe / depth: 350 mm / 13,8 inch  
Lackierung / finish: eisen-natur / iron nature  
Gewicht / weight: 8,8 kg

## H 16935 Barhocker / bar stool

Höhe / height: 750 - 910 mm / 29,5 - 35,8 inch  
Breite / width: 440 mm / 17,3 inch  
Tiefe / depth: 350 mm / 13,8 inch  
Lackierung / finish: eisen-natur / iron nature  
Gewicht / weight: 10,4 kg

Bei dieser Theke wurde ein Teilstück der Golden Gate Bridge nachgestellt und exklusiv für das Restaurant Beach House California Kitchen in der Armin-Wolf-Baseball-Arena in Regensburg angefertigt.

This bar has been made like a section of the Golden Gate Bridge. The replica was made for the Restaurant Beach House California Kitchen in Regensburg, home of Germany's biggest Baseball Club, the Buchbinder Legionäre Regensburg.

La réalisation de ce bar s'inspire du célèbre Golden Gate Bridge. Il a été spécialement créé pour le « Beach House California Kitchen », restaurant favori de la célèbre équipe de baseball « Legionäre » de Ratisbonne.



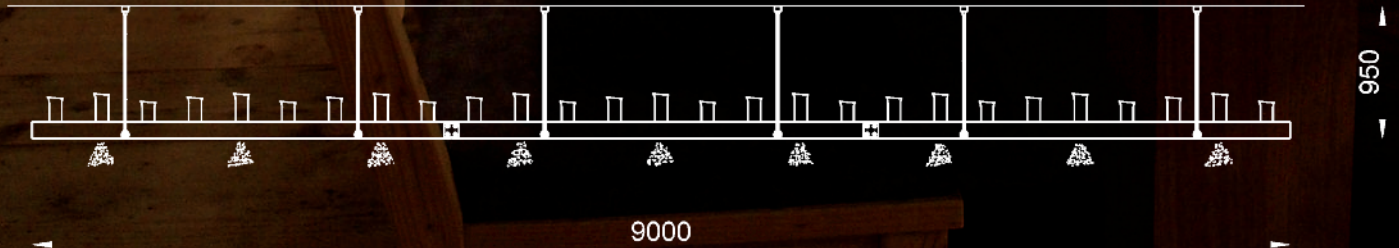

33.000.078-B



**HL 2548**

**HL 2548** 8-fl. Hängeleuchte / 8-lighter susp. lamp

Fassung / socket - EEK / EEC: 8 x E 27 / E 26 - A++ - E  
 mit / with Downlights: 4 x GU 10  
 Höhe / height: 363 mm / 14 inch  
 Durchmesser / diameter: 1000 mm / 39 inch  
 Glas / glass: 8 x Nr. 411 opal matt / frosted  
 Lackierung / finish: eisen-natur / iron nature  
 Gewicht / weight: 75 kg

Die Gesamthöhe der Leuchte, inklusive Aufhängung, wird Ihrem Wunsch entsprechend gefertigt.

The over all height of this fixture will be made according to your requirements.

La hauteur totale du luminaire, système d'attache compris, sera confectionné selon vos souhaits.

**33.000.078-B**

27-fl. Hängeleuchte / 27-lighter suspension lamp

Fassung / socket - EEK / EEC: 27 x E 27 / E 26 - A++ - E  
 mit / with Downlights: 9 x GU 10  
 Höhe / height: 320 mm / 12,5 inch  
 Breite / width: 186 mm / 7 inch  
 Länge / length: 9000 mm / 355 inch  
 Glas / glass: 9 x Nr. 388-OM / 9 x Nr. 346-OM  
 9 x Nr. 347-OM  
 Lackierung / finish: eisen-natur / iron nature  
 Gewicht / weight: 318 kg



**HL 2548**  
Detail



**WL 3580**

**WL 3580** Wandleuchte / wall lamp

Fassung / socket: 1 x E 27 / E 26  
 EEK / EEC: A++ - E  
 Höhe / height: 700 mm / 27,5 inch  
 Breite / width: 125 mm / 5 inch  
 Ausladung / distance to wall: 120 mm / 5 inch  
 Glas / glass: Nr. 411 opal matt / frosted  
 Lackierung / finish: eisen-natur / iron nature  
 Gewicht / weight: 5,5 kg

**WL 3581**  
 Wandkerzenhalter inklusive Altarkerzen /  
 wall candle stick including church candles

Höhe / height: 700 mm / 27,5 inch  
 Breite / width: 720 mm / 28 inch  
 Ausladung / distance to wall: 100 mm / 4 inch  
 Lackierung / finish: eisen-natur / iron nature  
 Gewicht / weight: 30 kg



**HL 2547**  
 Detail

**HL 2547** 5-fl. Hängeleuchte /  
 5-lighter suspension lamp

Fassung / socket: 5 x E 27 / E 26  
 mit / with Downlights: 3 x GU 10  
 EEK / EEC: A++ - E  
 Höhe / height: 400 mm / 15,8 inch  
 Breite / width: 100 mm / 4 inch  
 Länge / length: 1300 mm / 51 inch  
 Glas / glass: 5 x Nr. 411 opal matt / frosted  
 Lackierung / finish: eisen-natur / iron nature  
 Gewicht / weight: 33 kg

Die Gesamthöhe der Leuchte, inklusive Aufhängung, wird Ihrem Wunsch entsprechend gefertigt.

The over all height of this fixture will be made according to your requirements.

La hauteur totale du luminaire, système d'attache compris, sera confectionné selon vos souhaits.



**WL 3581**





23.662.000-D2  
Detail



# FLIEGERHORST

ESCHBACH, GERMANY

25.000.697





**23.662.000-D2**  
**Handlauf**



2.936.000

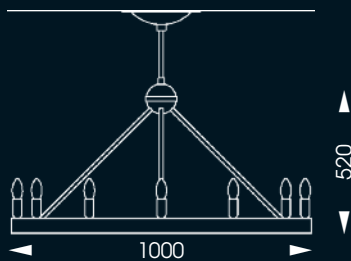

ART: 2.936.000



**2.936.000** 12-fl. Hängeleuchte /  
12-lighter suspension lamp

Fassung / socket: 12 x E 14 / E 12  
 EEK / EEC: A++ - E  
 Höhe / height: 520 mm / 20,5 inch  
 Durchmesser / diameter: 1000 mm / 39 inch  
 Lackierung / finish: Messing-antik / brass antique

**2.936.002 (Skizze)** 72-fl. Hängeleuchte /  
72-lighter suspension lamp

Fassung / socket: 72 x E 14 / E 12  
 EEK / EEC: A++ - E  
 Höhe / height: 1100 mm / 43,3 inch  
 Durchmesser / diameter: 1400 mm / 55 inch  
 Lackierung / finish: Messing-antik / brass antique

Die Gesamthöhe der Leuchte, inklusive Aufhängung, wird Ihrem Wunsch entsprechend gefertigt.

The over all height of this fixture will be made according to your requirements.

La hauteur totale du luminaire, système d'attache compris, sera confectionné selon vos souhaits.

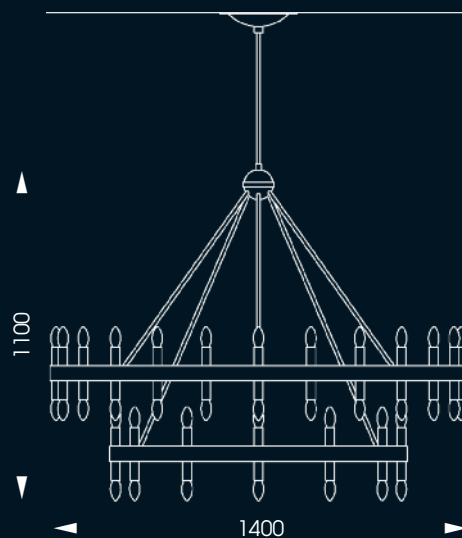

ART: 2.936.002





**HL 2428**

**HL 2428** 4-fl. Hängeleuchte /  
4-lighter suspension lamp

Fassung / socket: 4 x E 14 / E 12  
 EEK / EEC: A++ - E  
 Höhe / height: 820 mm / 32 inch  
 Breite / width: 342 mm / 14 inch  
 Glas / glass: 1 x Nr. 348 klar / clear  
 4 x Nr. 351-OM

Lackierung / finish: patina  
 Baldachin / canopy: B 38  
 Kette / chain: K 1160 - 1 m  
 Gewicht / weight: 12 kg

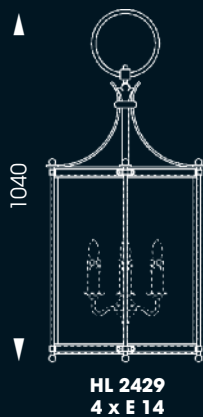

**WL 3483**

**WL 3483** 2-fl. Wandleuchte / 2-lighter wall lamp

Fassung / socket: 2 x E 14 / E 12  
 EEK / EEC: A++ - E  
 Höhe / height: 490 mm / 19,5 inch  
 Breite / width: 350 mm / 13,5 inch  
 Ausladung / distance to wall: 200 mm / 7,8 inch  
 Glas / glass: 1 x Nr. 350 klar / clear  
 2 x Nr. 351-OM

Lackierung / finish: patina  
 Gewicht / weight: 11,5 kg

**WL 3499** Wandleuchte / wall lamp

Fassung / socket: 1 x E 14 / E 12  
 EEK / EEC: A++ - E  
 Höhe / height: 330 mm / 13 inch  
 Breite / width: 250 mm / 9,8 inch  
 Ausladung / distance to wall: 150 mm / 5,9 inch  
 Glas / glass: 1 x Nr. 315 klar / clear  
 1 x Nr. 351-OM

Lackierung / finish: patina  
 Gewicht / weight: 5 kg



**WL 3499**



**HL 2489**



**HL 2489** 6-fl. Hängeleuchte /  
6-lighter suspension lamp

Fassung / socket - EEK / EEC: 6 x E 14 / E 12 - A++ - E  
 Höhe / height: 480 mm / 19 inch  
 Breite / width: 565 mm / 22 inch  
 Länge / length: 860 mm / 34 inch  
 Glas / glass: 6 x Nr. 351-OM  
 Lackierung / finish: patina  
 Baldachin / canopy: B 34  
 Kette / chain: K 1161 - 1 m  
 Gewicht / weight: 10,6 kg

**HL 2506** 4-fl. Hängeleuchte /  
4-lighter suspension lamp

Fassung / socket - EEK / EEC: 4 x E 14 / E 12 - A++ - E  
 Höhe / height: 460 mm / 18 inch  
 Breite / width: 600 mm / 23,6 inch  
 Glas / glass: 4 x Nr. 351-OM  
 Lackierung / finish: patina  
 Baldachin / canopy: B 34  
 Kette / chain: K 1161 - 1 m  
 Gewicht / weight: 8 kg

Nennen Sie uns den Wunschttext für Ihre persönliche Leuchte.

You give us your text and get your personal lighting fixture.

Personnalisation des plaques, selon votre demande.





**WL 3660**

**WL 3661**

**WL 3662**



**WL 3660  
Detail**

### **WL 3660** Wandleuchte / wall lamp

Fassung / socket - EHK / EEC: 1 x E 27 / E 26 - A++ - E  
 Höhe / height: 650 mm / 25,6 inch  
 Breite / width: 140 mm / 5,5 inch  
 Ausladung / distance to wall: 160 mm / 6 inch  
 Lackierung / finish: terra  
 Gewicht / weight: 2,8 kg

### **WL 3661** Wandleuchte / wall lamp

Fassung / socket - EHK / EEC: 1 x E 27 / E 26 - A++ - E  
 Höhe / height: 740 mm / 29 inch  
 Breite / width: 170 mm / 6,7 inch  
 Ausladung / distance to wall: 150 mm / 6 inch  
 Lackierung / finish: terra  
 Gewicht / weight: 2,8 kg

### **WL 3662** Wandleuchte / wall lamp

Fassung / socket - EHK / EEC: 1 x E 27 / E 26 - A++ - E  
 Höhe / height: 600 mm / 23,5 inch  
 Breite / width: 160 mm / 6,3 inch  
 Ausladung / distance to wall: 150 mm / 6 inch  
 Lackierung / finish: terra  
 Gewicht / weight: 2,8 kg



### SL 112 Stehleuchte / floor lamp

Fassung / socket: 1 x E 27 / E 26  
 EEK / EEC: A++ - E  
 Höhe / height: 1600 mm / 63 inch  
 Breite / width: 300 mm / 12 inch  
 Schirm / shade: SC 2016  
 Durchmesser / diameter: 300 mm / 12 inch  
 Höhe / height: 500 mm / 19,7 inch  
 Lackierung / finish: terra  
 Gewicht / weight: 21,6 kg

### TL 4104 Tischleuchte / table lamp

Fassung / socket: 1 x E 27 / E 26  
 EEK / EEC: A++ - E  
 Höhe / height: 600 mm / 23,5 inch  
 Breite / width: 200 mm / 8 inch  
 Schirm / shade: SC 2017  
 Durchmesser / diameter: 200 mm / 8 inch  
 Höhe / height: 300 mm / 12 inch  
 Lackierung / finish: terra  
 Gewicht / weight: 6,6 kg



SL 112  
Detail



TL 4104

SL 112



**HL 2424**

**HL 2424** Hängeleuchte / suspension lamp

Fassung / socket: 1 X E 27 / E 26  
 EEK / EEC: A++ - E  
 Höhe / height: 510 mm / 20 inch  
 Breite / width: 240 mm / 9,4 inch  
 Glas / glass: Nr. 339  
 amber innen gestrahlt / amber inside frosted

Lackierung / finish: patina  
 Baldachin / canopy: B 38  
 Kette / chain: K 1160 - 1 m  
 Gewicht / weight: 11,5 kg

**HL 2422-N** 4-fl. Hängeleuchte / 4-lighter suspension lamp

Fassung / socket: 4 x E 27 / E 26  
 mit / with Downlights: 4 x GU 10  
 EEK / EEC: A++ - E  
 Höhe / height: 320 mm / 12 inch  
 Breite / width: 700 mm / 28 inch  
 Glas / glass: 4 x Nr. 340  
 amber innen gestrahlt / amber inside frosted

Lackierung / finish: patina  
 Baldachin / canopy: B 38  
 Kette / chain: K 1160 - 1 m  
 Gewicht / weight: 24,8 kg



**HL 2422-N**





HL 2425-N





**WL 3477**

**WL 3478**

**HL 2425-N** 12-fl. Hängeleuchte /  
12-lighter suspension lamp

Fassung / socket: 12 x E 27 / E 26  
 mit / with Downlights: 4 x GU 10  
 EEK / EEC: A++ - E  
 Höhe / height: 510 mm / 20 inch  
 Breite / width: 1100 mm / 43 inch  
 Glas / glass: 12 x Nr. 340  
 amber innen gestrahlt / amber inside frosted  
 patina  
 Lackierung / finish: B 39  
 Baldachin / canopy:  
 Kette/chain: K 1160 - 1 m  
 Gewicht / weight: 42 kg

**WL 3477** Wandleuchte / wall lamp

Fassung / socket: 1 x E 27 / E 26  
 EEK / EEC: A++ - E  
 Höhe / height: 680 mm / 27 inch  
 Breite / width: 140 mm / 5,5 inch  
 Ausladung/ distance to wall: 210 mm / 8 inch  
 Glas / glass: Nr. 340  
 amber innen gestrahlt / amber inside frosted  
 patina  
 Lackierung / finish:  
 Gewicht / weight: 7 kg

**WL 3478** Wandleuchte / wall lamp

Fassung / socket: 1 x E 27 / E 26  
 EEK / EEC: A++ - E  
 Höhe / height: 950 mm / 37 inch  
 Breite / width: 210 mm / 8 inch  
 Ausladung/ distance to wall: 300 mm / 12 inch  
 Glas / glass: Nr. 339  
 amber innen gestrahlt / amber inside frosted  
 patina  
 Lackierung / finish:  
 Gewicht / weight: 12,5 kg

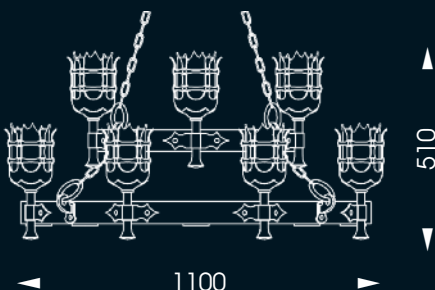



**WL 903**

**WL 903 3-fl. Wandleuchte / 3-lighter wall lamp**

Fassung / socket: 3 x E 14 / E 12  
 EEK / EEC: A++ - E  
 Höhe / height: 450 mm / 17,7 inch  
 Breite / width: 380 mm / 15 inch  
 Ausladung / distance to wall: 220 mm / 8,7 inch  
 Glas / glass: 3 x Nr. 351-OM  
 Lackierung / finish: patina  
 Gewicht / weight: 6 kg

**WL 901 Wandleuchte / wall lamp**

Fassung / socket: 1 x E 14 / E 12  
 EEK / EEC: A++ - E  
 Höhe / height: 350 mm / 13,8 inch  
 Breite / width: 110 mm / 4,3 inch  
 Ausladung / distance to wall: 220 mm / 8,7 inch  
 Glas / glass: Nr. 351-OM  
 Lackierung / finish: patina  
 Gewicht / weight: 3,5 kg

**HL 853 12-fl. Hängeleuchte / suspension lamp**

Fassung / socket - EEK / EEC: 12 x E 14 / E 12 - A++ - E  
 Höhe / height: 720 mm / 28,3 inch  
 Breite / width: 950 mm / 37,4 inch  
 Glas / glass: 12 x Nr. 351-OM  
 Lackierung / finish: patina  
 Baldachin / canopy: B 39  
 Haken / hooks: B 196  
 Gewicht / weight: 58 kg

**HL 851 6-fl. Hängeleuchte / suspension lamp**  
 (ohne Abbildung / without picture)

Fassung / socket - EEK / EEC: 6 x E 14 / E 12 - A++ - E  
 Höhe / height: 420 mm / 16,5 inch  
 Breite / width: 670 mm / 26,4 inch  
 Glas / glass: 6 x Nr. 351-OM  
 Baldachin / canopy: B 39  
 Haken / hooks: B 196  
 Gewicht / weight: 28 kg

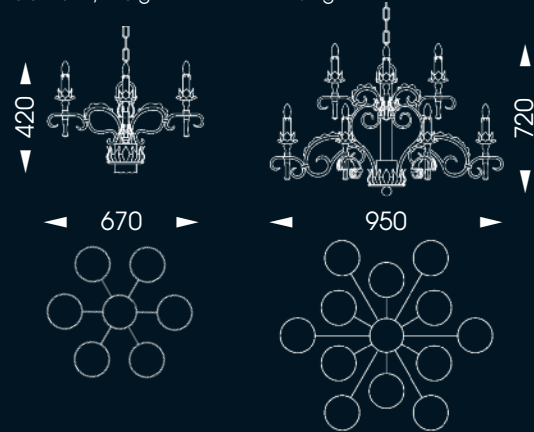

**HL 851**

**HL 853**



**WL 901**



HL 853



**WL 3327**



**DE 2246**

**HL 2245 Hängeleuchte / suspension lamp**

Fassung / socket - EEK / EEC: 4 x E 14 / E 12 - A++ - E  
 Höhe / height: 630 mm / 24,8 inch  
 Breite / width: 320 mm / 12,6 inch  
 Glas / glass: Nr. 133 antika  
 Lackierung / finish: old bronze  
 Baldachin / canopy: B 34  
 Haken / hooks: B 199  
 Gewicht / weight: 7,5 kg

**WL 3327 Wandleuchte / wall lamp**

Fassung / socket - EEK / EEC: 2 x E 14 / E 12 - A++ - E  
 Höhe / height: 400 mm / 14,2 inch  
 Breite / width: 280 mm / 11 inch  
 Ausladung / distance to wall: 160 mm / 6,3 inch  
 Glas / glass: Nr. 226 antika  
 Lackierung / finish: old bronze  
 Gewicht / weight: 5,0 kg

**DE 2246 Deckenleuchte / ceiling lamp**

Fassung / socket - EEK / EEC: 4 x E 14 / E 12 - A++ - E  
 Höhe / height: 350 mm / 13,8 inch  
 Breite / width: 320 mm / 12,6 inch  
 Glas / glass: Nr. 133 antika  
 Lackierung / finish: old bronze  
 Gewicht / weight: 7,0 kg



**HL 2245**



**HL 2245  
Detail**



**Baldachin  
B 34**



**B 8622**  
Detail



**B 8622**  
Detail



**B 8622**

**B 8622** Weinregal / wine cage

Höhe / height: 1600 mm / 63 inch  
 Breite / width: 700 mm / 27.5 inch  
 Tiefe / depth: 400 mm / 15.8 inch  
 Lackierung / finish: patina  
 Gewicht / weight: 115 kg

**HL 2441-ST** 4-fl. Hängeleuchte / suspension lamp

Fassung / socket - EEK / EEC: 4 x E 14 / E 12 - A++ - E  
 mit / with Downlights: 4 x GU 10  
 Höhe / height: 900 mm / 35.5 inch  
 Breite / width: 630 mm / 25 inch  
 Glas / glass: 4 x Nr. 344-OM  
 Lackierung / finish: old black  
 Baldachin / canopy: B 34  
 Kette / chain: K 1160 - 1 m  
 Gewicht / weight: 14 kg

**HL 2444-ST** 12-fl. Hängeleuchte / suspension lamp

Fassung / socket - EEK / EEC: 12 x E 14 / E 12 - A++ - E  
 mit / with Downlights: 4 x GU 10  
 Höhe / height: 1280 mm / 50.5 inch  
 Breite / width: 1050 mm / 41.5 inch  
 Glas / glass: 12 x Nr. 344-OM  
 Lackierung / finish: old black  
 Baldachin / canopy: B 34  
 Kette / chain: K 1160 - 1 m  
 Gewicht / weight: 30 kg



**B 8622**  
Detail



HL 2441-ST



HL 2444-ST

**WL 3489** 2-fl. Wandleuchte / 2-lighter wall lamp

Fassung / socket - EEK / EEC: 2 x E 14 / E 12 - A++ - E  
 Höhe / height: 380 mm / 15 inch  
 Breite / width: 320 mm / 12,5 inch  
 Ausladung / distance to wall: 165 mm / 6,5 inch  
 Glas / glass: 2 x Nr. 344-OM  
 Lackierung / finish: old black  
 Gewicht / weight: 2,7 kg

**WL 3488** Wandleuchte / wall lamp

Fassung / socket - EEK / EEC: E 14 / E 12 - A++ - E  
 Höhe / height: 380 mm / 15 inch  
 Breite / width: 160 mm / 6 inch  
 Ausladung / distance to wall: 205 mm / 8 inch  
 Glas / glass: Nr. 344-OM  
 Lackierung / finish: old black  
 Gewicht / weight: 1,8 kg

Kerzenhülsen aus Glas /  
 candle cover out of glass



elfenbein  
 ivory



opalmatt  
 opal frosted

WL 3489

WL 3488





HL 2594-N





**HL 2594-N**  
Detail

**HL 2594-N** 20-fl. Hängeleuchte mit Kette /  
20-lighter suspension lamp with chain

|                      |   |
|----------------------|---|
| Fassung / socket:    | 20 x E 14 / E 12  |
| EEK / EEC:           | A++ - E   |
| Höhe / height:       | 1670 mm / 65.7 inch   |
| Breite / width:      | 1730 mm / 68 inch   |
| Glas / glass:        | 20 x Nr. 474 champagner   |
| Baldachin / canopy:  | B 41  |
| Kette / chain:       | K 1163 - 1 m  |
| Lackierung / finish: | Messing antik mit Blattgold Details /<br>brass antique with gold leaf details |
| Gewicht / weight:    | 160 kg  |



1730



**HL 2594-N**  
Detail



**WL 3618-N**

**WL 3618-N** 2-fl. Wandleuchte / 2-lighter wall lamp

|                               |   |
|-------------------------------|---|
| Fassung / socket:             | 2 x E 14 / E 12   |
| EEK / EEC:                    | A++ - E   |
| Höhe / height:                | 520 mm / 20.4 inch  |
| Breite / width:               | 570 mm / 22.4 inch  |
| Ausladung / distance to wall: | 270 mm / 10.6 inch  |
| Glas / glass:                 | 2 x Nr. 474 champagner  |
| Lackierung / finish:          | Messing antik mit Blattgold Details /<br>brass antique with gold leaf details |
| Gewicht / weight:             | 9,5 kg  |

**WL 3619-N** 3-fl. Wandleuchte / 3-lighter wall lamp

|                               |   |
|-------------------------------|---|
| Fassung / socket:             | 3 x E 14 / E 12   |
| EEK / EEC:                    | A++ - E   |
| Höhe / height:                | 620 mm / 24.4 inch  |
| Breite / width:               | 570 mm / 22.4 inch  |
| Ausladung / distance to wall: | 270 mm / 10.6 inch  |
| Glas / glass:                 | 3 x Nr. 474 champagner  |
| Lackierung / finish:          | Messing antik mit Blattgold Details /<br>brass antique with gold leaf details |
| Gewicht / weight:             | 11 kg   |



**WL 3619-N**

25.000.778-J3

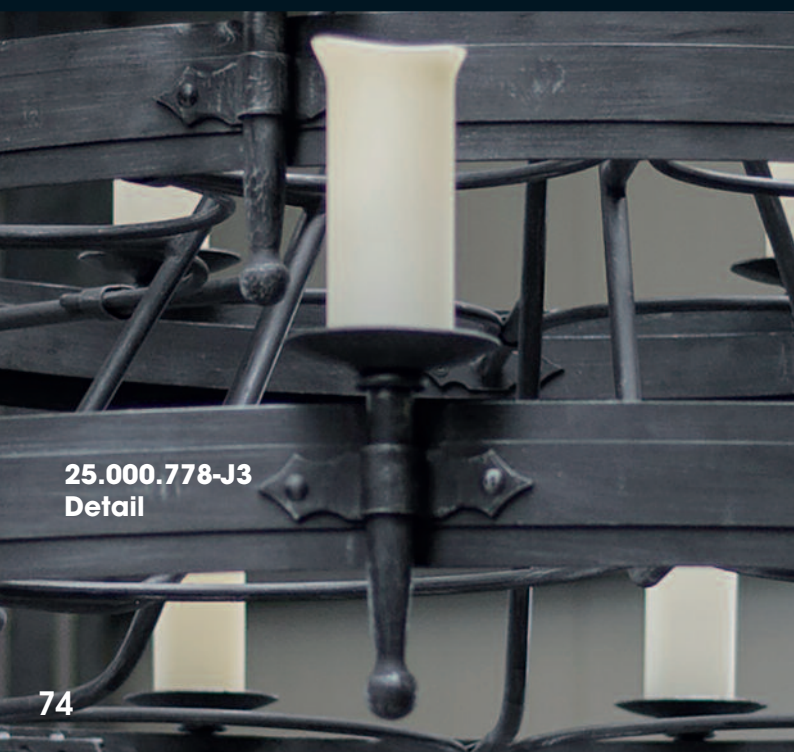

25.000.778-J3  
Detail

### 25.000.778-J3

24-fl. Hängeleuchte / 24-lighter suspension lamp

Fassung / socket – EEK / EEC: 24 x E 27 / E 26 – A++ – E  
Höhe / height: 1430 mm / 56,3 inch  
Durchmesser / diameter: 2500 mm / 98,4 inch  
Glass / glass: 24 x Nr. 347-EB  
Baldachin / canopy: B 39  
Kette / chain: K 1163 - 1 m  
Lackierung / finish: eisen-natur / iron nature  
Gewicht / weight: 225 kg

### 25.000.573-F

12-fl. Hängeleuchte / 12-lighter suspension lamp

Fassung / socket – EEK / EEC: 12 x GU10 – A++ – E  
Höhe / height: 1200 mm / 47 inch  
Durchmesser / diameter: 2200 mm / 86,6 inch  
Lackierung / finish: eisen-natur / iron nature  
Gewicht / weight: 50 kg

25.000.573-F

LANDGUT  
AM HOCHWALD  
SONSBECK, GERMANY



25.000.573-F  
Detail

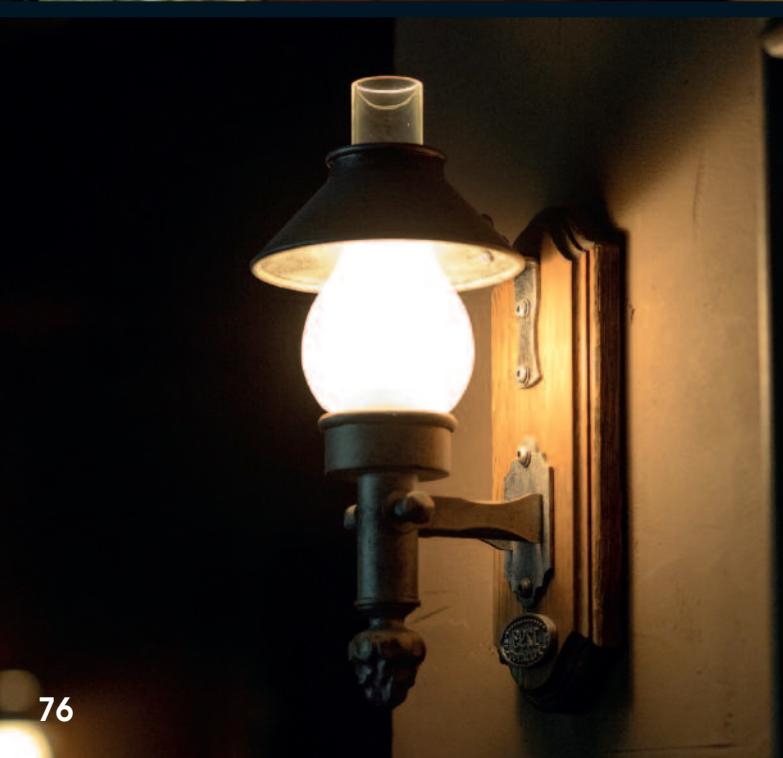

PUY DU FOU®  
FRANCE





**23.402.000-C**

**23.402.000-C**

Treppengeländer für eine Privatvilla  
aus Schmiedeeisen /  
banister for a privat villa  
out of wrought iron /  
Rampe d'escalier en fer forgé  
d'une villa privée

Lackierung / finish:

Zinn / pewter







**2.999.106** 16 fl. Hängeleuchte /  
16-lighter suspension lamp

Fassung / socket: 12 x E 14 / E 12  
4 x E 27 / E 26  
EEK / EEC: A++ - E  
Höhe / height: 2120 mm / 83,5 inch  
Breite / width: 2100 mm / 82,7 inch  
Glas / glass: 12 x Nr. 295 opal / 4 x Nr. 296 opal  
4 x Nr. 297 klar/clear  
Lackierung / finish: Messing antik / brass antique

Rekonstruktion einer 16-flammigen Hängeleuchte nach historischen Vorlagen für das Dorint-Hotel in Baden-Baden.

16-lighter suspension lamp reconstructed corresponding to a historical Photo for the Dorint-Hotel in Baden-Baden, Germany.

Lampe de suspension 16-fl reconstituée à partir d'une ancienne photographie, pour l'hôtel Dorint à Baden-Baden en Allemagne.



# OBERFLÄCHEN / COLOURS



EISEN-NATUR / IRON NATURE



PATINA

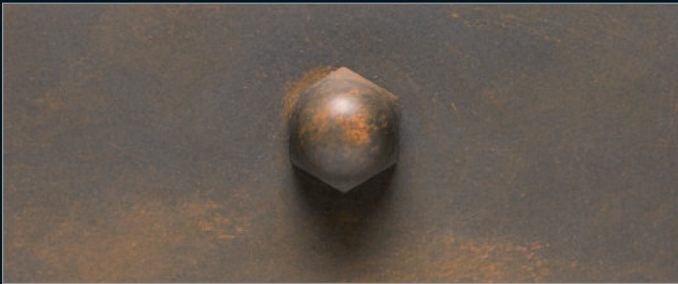

EISEN ROSTIG / IRON RUSTY

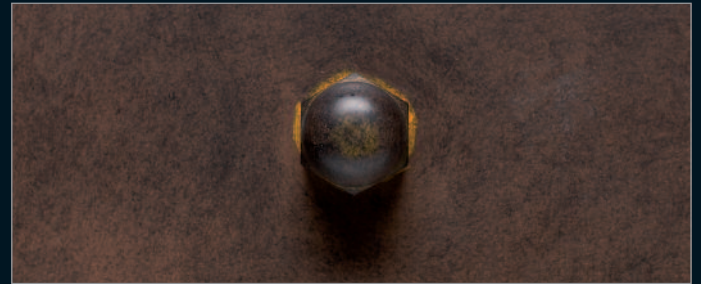

TERRA

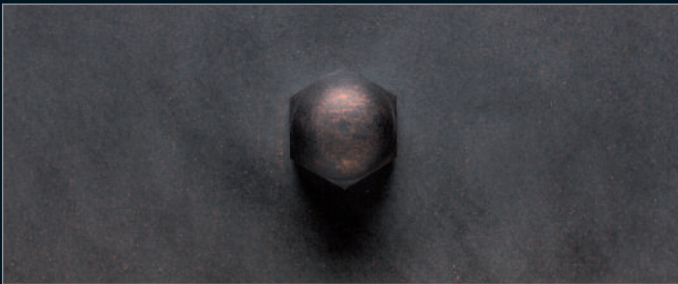

OLD COPPER

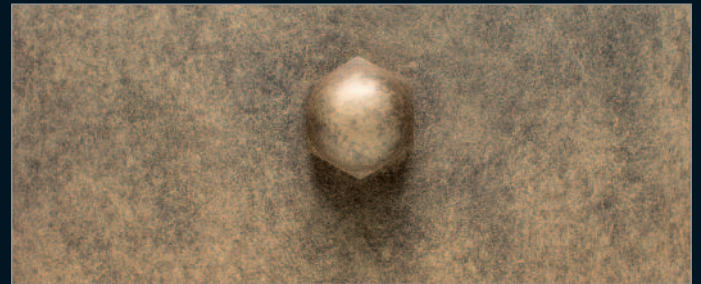

MESSING ANTIK / BRASS ANTIQUE



OLD BRONZE



VINTAGE



SCHWARZ SILBER / BLACK SILVER

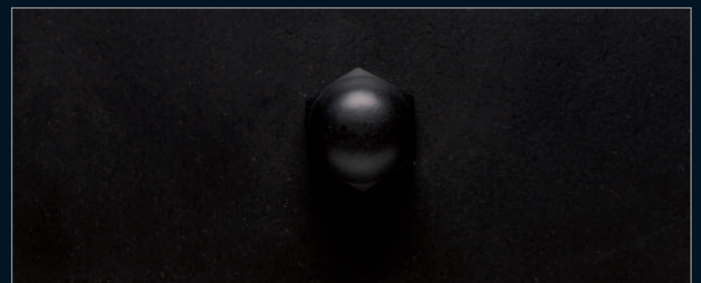

OLD BLACK

Alle Leuchten werden von Hand lackiert, leichte Farbabweichungen sind daher möglich. Selbstverständlich können die Leuchten auch in jeder RAL-Farbe lackiert werden.

The final finish is made by hand, therefore slight colour differences are possible. Of course also every RAL colour is possible.

Toutes les patines de finition sont peintes à la main, c'est pourquoi de légères nuances de teinte sont possibles. Toutes les couleurs RAL sont également réalisables.

# QUALITÄT UND SICHERHEIT

Alle Leuchten und Sonderanfertigungen werden gemäß der aktuellen Norm EN60598/VDE0711 und der aktuellen europäischen Verordnung (CE) entwickelt und gefertigt. Jede Leuchte wird auf Funktion und Sicherheit geprüft und versandfertig verpackt.

## Energieeffizienz

Die Lieferung unserer Leuchten erfolgt ohne Leuchtmittel. Wir setzen bei der Konstruktion unserer Leuchten auf die Verwendung von Retrofit-Leuchtmitteln. Sie können mit energiesparenden LED-Lampen bis dekorativen Glühbirnen bestückt werden. Die Kennzeichnung erfolgt nach der EU-Verordnung 874/2012 und 518/2014 auf einem Energielabel.

Wir geben Ihnen gerne eine Empfehlung zu verschiedenen LED-Lampen.

## Unsere Leuchten sind geeignet für Lampen der EEK:



## Aufhängung

Unsere Hängeleuchten werden mit passendem Baldachin und standardmäßig 1 Meter Kette geliefert. Sondergrößen werden speziell gefertigt und dem Leuchtengewicht angepasst.



Nr. 34

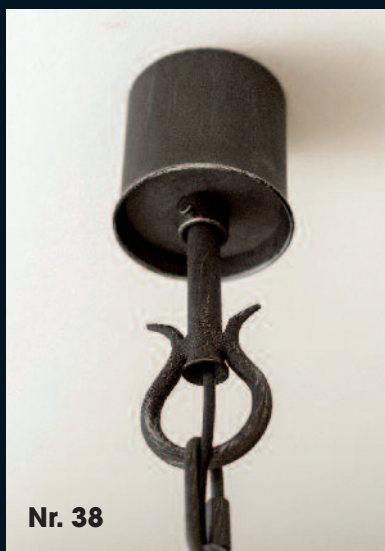

Nr. 38

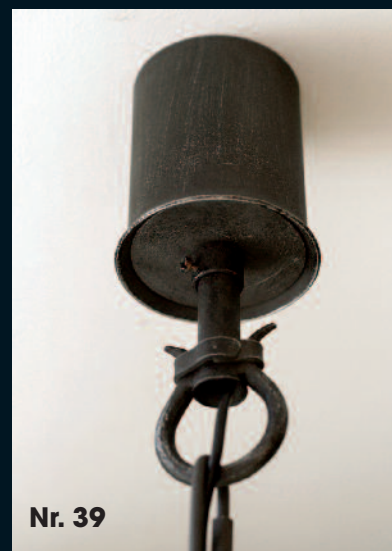

Nr. 39

## Mundgeblasene Gläser

Kennzeichnend für ein mundgeblasenes Glas ist die handwerkliche Herstellung, somit stellt jedes Glas ein Unikat dar. Kleine Lufteinschlüsse im Glas sind ein Qualitätszeichen für die aufwendige Herstellung.

## Technische Sonderwünsche

Gerne gehen wir auf technische Sonderwünsche ein. If you need special technical solutions, please ask us.

**Änderungen bleiben vorbehalten. Für Satzfehler und Farbabweichungen wird keine Haftung übernommen.**

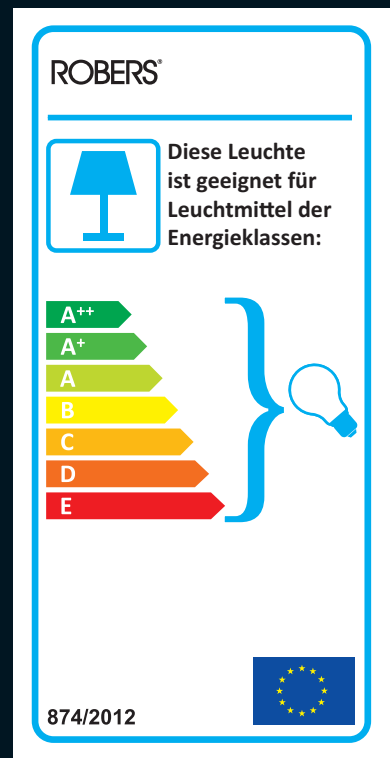

# INHALTSVERZEICHNIS / INDEX

## HÄNGELEUCHTEN SUSPENSION LAMPS

|             |        |
|-------------|--------|
| HL 851      | .66    |
| HL 853      | .67    |
| HL 2245     | .69    |
| HL 2422-N   | .62/63 |
| HL 2424     | .62    |
| HL 2425-N   | .64    |
| HL 2428     | .57    |
| HL 2429     | .57    |
| HL 2430     | .22/23 |
| HL 2441-ST  | .71    |
| HL 2444-ST  | .71    |
| HL 2452     | .57    |
| HL 2489     | .58    |
| HL 2491     | .26    |
| HL 2506     | .59    |
| HL 2509     | .20/21 |
| HL 2547     | .52/53 |
| HL 2548     | .51    |
| HL 2555     | .13    |
| HL 2557     | .10/11 |
| HL 2560     | .18/19 |
| HL 2569-300 | .45    |
| HL 2569-400 | .44/45 |
| HL 2569-500 | .45    |
| HL 2594-N   | .72/73 |
| HL 2630     | .6/7   |
| HL 2633     | .29    |
| HL 2636     | .14/15 |
| HL 2637     | .9     |
| HL 2641     | .46/47 |
| HL 2642     | .46    |

## STEHLEUCHTEN FLOOR LAMPS

|        |     |
|--------|-----|
| SL 105 | .24 |
| SL 109 | .33 |
| SL 111 | .8  |
| SL 112 | .61 |
| SL 113 | .37 |

## TISCHLEUCHTEN TABLE LAMPS

|         |     |
|---------|-----|
| TL 4100 | .24 |
| TL 4103 | .8  |
| TL 4104 | .61 |

## STRAHLER SPOTS

|         |     |
|---------|-----|
| ST 2614 | .41 |
| ST 2615 | .40 |
| ST 2619 | .40 |
| ST 2628 | .41 |

## WANDLEUCHTEN WALL LAMPS

|            |        |
|------------|--------|
| WL 901     | .66    |
| WL 903     | .66    |
| WL 3327    | .68    |
| WL 3477    | .65    |
| WL 3478    | .65    |
| WL 3483    | .57    |
| WL 3484    | .21    |
| WL 3484-ST | .21    |
| WL 3488    | .71    |
| WL 3489    | .71    |
| WL 3499    | .57    |
| WL 3576    | .20    |
| WL 3580    | .52    |
| WL 3581    | .52    |
| WL 3582    | .12/15 |
| WL 3583    | .12    |
| WL 3603    | .21    |
| WL 3618-N  | .73    |
| WL 3619-N  | .73    |
| WL 3625    | .25    |
| WL 3645    | .8     |
| WL 3651    | .28    |
| WL 3654    | .27    |
| WL 3655    | .27    |
| WL 3656    | .27    |
| WL 3657    | .14    |
| WL 3660    | .60    |
| WL 3661    | .60    |
| WL 3662    | .60    |
| WL 3663    | .36    |
| WL 3673    | .35    |

## DECKENLEUCHTEN CEILING LAMPS

|         |        |
|---------|--------|
| DE 2246 | .68    |
| DE 2550 | .32    |
| DE 2551 | .32    |
| DE 2552 | .32    |
| DE 2626 | .34    |
| DE 2627 | .34    |
| DE 2638 | .16/17 |

## ACCESSOIRES ACCESSORIES

|                    |        |
|--------------------|--------|
| H 16934 Barhocker  | .48/49 |
| H 16935 Barhocker  | .48/49 |
| B 8622 Weinregal   | .70    |
| B 8674 Blumenampel | .10    |

## SONDERANFERTIGUNGEN CUSTOM MADE

|                              |        |
|------------------------------|--------|
| 2.936.000 Hängeleuchte       | .56    |
| 2.936.002 Hängeleuchte       | .56    |
| 2.999.106 Hängeleuchte       | .80    |
| 23.402.000-C Treppengeländer | .78/79 |
| 23.662.000-D2 Handlauf       | .54/55 |
| 25.000.573-B Hängeleuchte    | .22    |
| 25.000.573-F Hängeleuchte    | .75    |
| 25.000.624-C Hängeleuchte    | .38/39 |
| 25.000.697 Hängeleuchte      | .54    |
| 25.000.777-B Hängeleuchte    | .43    |
| 25.000.777-D Tischleuchte    | .42    |
| 25.000.778-J3 Hängeleuchte   | .74    |
| 25.000.781-H1 Thekenleuchte  | .49    |
| 33.000.078-B Hängeleuchte    | .50    |
| 33.000.087-A1 Hängeleuchte   | .30/31 |
| 33.000.087-B1 Wandleuchte    | .30    |

ÄNDERUNGEN IN FORM UND AUSFÜHRUNG  
UNSERER LEUCHTEN BLEIBEN UNS VORBEHALTEN.  
ALLE MASSE UND GEWICHTE SIND CIRCA  
ANGABEN AUFGRUND DER HANDWERKLICHEN  
FERTIGUNG.

WE RESERVE US THE RIGHT TO CHANGE THE  
SHAPE AND DESIGN OF OUR LIGHTING FIXTURES.  
ALL MEASUREMENTS AND WEIGHT DECLARATIONS  
ARE APPROXIMATE DUE TO THE HAND MADE  
PRODUCTION.

NOUS NOUS RESERVONS LE DROIT DE MODIFIER  
LES CARACTERISTIQUES DE NOS PRODUITS SANS  
PREAVIS. LES DIMENSIONS ET LES POIDS SONT  
APPROXIMATIFS EN RAISON DE LA FABRICATION  
ARTISANALE DE NOS PRODUITS.

**HANDMADE  
LIGHTING  
FROM  
GERMANY**

**ROBERS®**

ROBERS-LEUCHTEN  
GmbH & Co. KG  
Weseker Weg 36  
46354 Südlohn - Germany  
Tel.: ++49 (0) 28 62 - 99 77 - 0  
Fax: ++49 (0) 28 62 - 99 77 77  
Net: [www.Robers.com](http://www.Robers.com)  
Mail: [office@Robers.com](mailto:office@Robers.com)